

**HYBEC<sup>®</sup> PRO**  
lighting the future

*An aura of exclusivity...*



[www.hybec.net](http://www.hybec.net)

## ABOUT OUR HYBECPRO SERIES



### We are HYBECPRO.

The challenging art of minimalism, where every tiny detail is accounted for, inspired us to create our new product line with unprecedented aesthetic value and at the same time, profound functionality. Our International design team is working fanatically to develop our product range with best light performance focussing on each element from the whole concept to the tiniest detail.

HYBECPRO series, with more than 1000 selection, can answer all possible lighting demands. Our products are made with care for each detail designed to decorate indoor and outdoor spaces, offering best lighting solutions according to modern tendencies. Being a young company, we are focussing on most advanced LED technology, innovative solutions and fashionable design. For a short period of time, HYBECPRO series has already conquered the hearts of thousands designers and architects providing best lighting experience and knowledge to meet the functional and aesthetic needs.

## RESEARCH & DEVELOPMENT



Design and development of HYBECPRO new collections are inspired by new trends in technology and advanced engineering solutions. The lighting industry is constantly changing, and HYBEC's professional in-house design bureau in co-operation with leading designers and consultancies, is constantly studying the markets, materials, methods and applications to create the best lighting solutions. Our main principals are efficiency, flexibility, functionality and most advanced technology.

## TECHNOLOGY

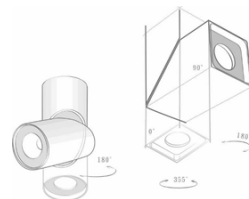

We deeply understand the importance of new technologies both in product development and production management. HYBECPRO has integrated the best and most advanced technologies in IT, production management and logistics to create CRM system to provide additional value added services to our customers and to make our cooperation more efficient and easier.

## PRODUCTION

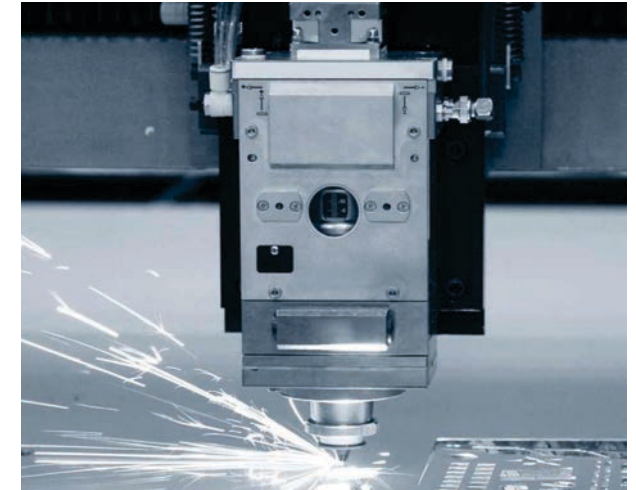

HYBECPRO lighting collection has grown to more than 1000 product references, ranging from indoor eye-catching design solutions and outdoor luminaires. We focus on details, from design and development to each production step.

Our production facilities contain most advanced equipment including aluminum foundry, 3D printing, and an advanced Design / Test laboratory. Finished products undergo strict quality testing.

## QUALITY



Throughout the production process HYBECPRO has developed strict quality parameters. Each step of production is strictly checked and tested. Careful selection of raw material's and electronic components, highly skilled professionals and innovative solutions are the result of high quality of HYBECPRO luminaires.

APPLICATION



RESIDENTIAL

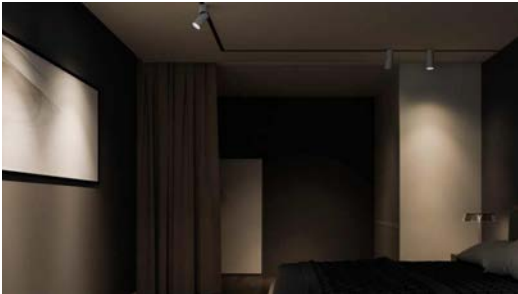

HOSPITALITY



MUSEUM / ART GALLERY



RETAIL

OUTDOOR

## BUSINESS COOPERATION

### MATERIALS & COMPONENTS



Careful selection of raw-materials and most innovative LED technology solutions in addition to professional craftsmanship and unique design are the keys to the success of our company. HYBECPRO is working in strong long term cooperation with worldwide leading manufacturers of materials and components. Advanced technologies, latest innovative achievements are deeply investigated in strong synergy with our suppliers in order to find the best solutions for our products.

### HYBECPRO PARTNERS

HYBECPRO recognizes the value and importance of our Distribution Channels. Our Partners are professional Agents and Distributors co-operating with HYBEC on long-term basis.

Companies given Agent and Distributor Partner status obtain certain stipulated business terms and conditions and joint IDEAS obligations / goals related to overall Sales (turnover) / Brand promotion.





HYBECPRO series is inspired by the European design tradition.

All source fittings in the premium series are hidden, to create a variety of light illusions. One flick of a switch can unveil the true power of your designs.

We work closely with Architects, Interior Designers, and Structural Engineers to achieve a concept that compliments the design and ensure a clean and bedazzling installation.

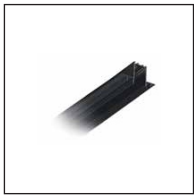

PRO-401 (0.5mtr)

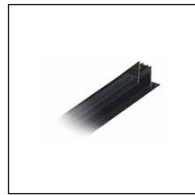

PRO-402 (1mtr)



PRO-403 (1.5mtr)



PRO-404 (2mtr)



PRO-411



PRO-412

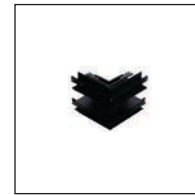

PRO-413



PRO-423



PRO-425



PRO-427

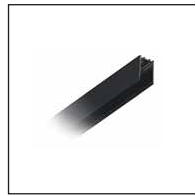

PRO-601 (1mtr)

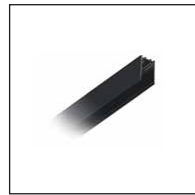

PRO-602 (1.5mtr)

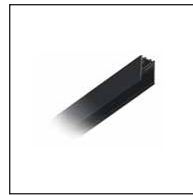

PRO-603 (2mtr)

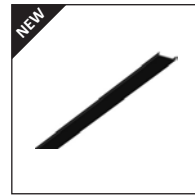

PRO-428 (1mtr-cover)

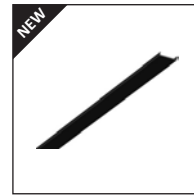

PRO-429 (2mtr-cover)



PRO-611



PRO-610



PRO-615



PRO-455 (2.2W)

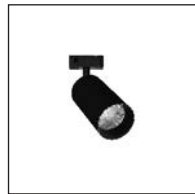

PRO-456 (7W)



PRO-457 (13W)



PRO-458 (18.5W)



PRO-459 (35.5W)



PRO-460 (2x2W)



PRO-465 (2x7W)

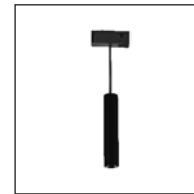

PRO-451 (18.5W)



PRO-452 (7W)



PRO-461 (5W)



PRO-462 (10W)



PRO-463 (18W)



PRO-464 (8W)



PRO-466 (10W)



PRO-468 (10W)



PRO-471 (3.3W)



PRO-472 (6.6W)



PRO-473 (10W)

## 48V MAGNETIC TRACK SERIES

PG. NO. : 01-37



PRO-475 (10W)  
Wall Washer



PRO-477 (12W)



PRO-480 (7W)



PRO-481 (14W)



PRO-482 (14W)

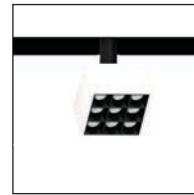

PRO-483 (7W)



PRO-484 (7W)



PRO-488 (20W)



PRO-489 (30W)

## LED LOW HEIGHT RECESSED LUMINAIRE SERIES

PG. NO. : 38-49



PRO-222 (9W)



PRO-222 (9W) + PF-04  
(TRIMLESS)



PRO-229 (9W)



PRO-229 (9W) + PF-06  
(TRIMLESS)



PRO-224 (9W)



PRO-224 (9W) + PF-04  
(TRIMLESS)



PRO-226 (7W)



PRO-226 (7W) + PF-04  
(TRIMLESS)



PRO-230 (7W)



PRO-230 (7W) + PF-04  
(TRIMLESS)



PRO-228 (9W)



PRO-228 (9W) + PF-04  
(TRIMLESS)

## GLARE-LESS DARK REFLECTOR SERIES

PG. NO. : 50-63



PRO-101 (6W / 9W)



P61



P62



P63



P65



P66



P67 (TRIMLESS)



P68 (TRIMLESS)



PRO-102 (9W)





P71



P72



P75 (Adjustable)



P73



P74



P76 (TRIMLESS)



P77 (TRIMLESS)



P79



P80



P81



P82-AJ (Adjustable)



P82 (Fixed)



P83



P84



P89



P85



P86



P87 (TRIMLESS)



P88 (TRIMLESS)



PRO-104 (15W)



P71



P72



P75 (Adjustable)



P73



P74



P76 (TRIMLESS)



P77 (TRIMLESS)



P79



P80



P81



P82-AJ (Adjustable)



P82 (Fixed)



P83



P84



P89



P85

**GLARE-LESS DARK REFLECTOR SERIES**



P86



P87 (TRIMLESS)



P88 (TRIMLESS)



PRO-106 (24W)



P90



P91



P92 (Adjustable)



P94 (TRIMLESS)



P95 (TRIMLESS)



P96



P97



PRO-107 (33W)



P93 (Adjustable)



P98



P99



PRO-108 (42W)



P100



P101

**SLIMMEST RIM DEEP RECESSED SERIES**



PRO-121 (4W)



R1



R2



R3



PRO-123 (8W)



R11



R12



R13



R14



R15



PRO-124 (13W)



R11



R12



R13



R14



R15



PRO-125 (20W)



R21

## SLIMMEST RIM DEEP RECESSED SERIES

PG. NO. : 64-71



R22



R23



PRO-122 (7W)



R11



R12



R13



R14



R15

## TRIMLESS EYEBALL SPOT LIGHT SERIES

PG. NO. : 72-75



PRO-121 (4W)



R5 (TRIMLESS)

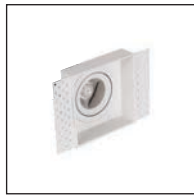

R6 (TRIMLESS)



PRO-123 (8W)



R26 (TRIMLESS)

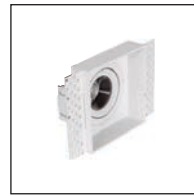

R27 (TRIMLESS)

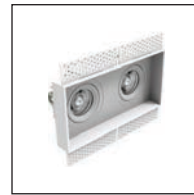

R28 (TRIMLESS)



PRO-124 (13W)



R26 (TRIMLESS)



R27 (TRIMLESS)

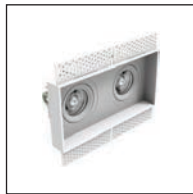

R28 (TRIMLESS)



PRO-125 (20W)



R24 (TRIMLESS)

## DIY TRIMLESS SPOT LIGHT SERIES

PG. NO. : 76-79



PRO-123 (8W)



R29 (TRIMLESS)



R30 (TRIMLESS)

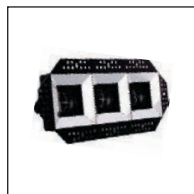

R31 (TRIMLESS)



R32 (TRIMLESS)



R33 (TRIMLESS)



B26 (FRAME)



PRO-124 (13W)



R29 (TRIMLESS)

DIY TRIMLESS SPOT LIGHT SERIES

PG. NO. : 76-79



R30 (TRIMLESS)

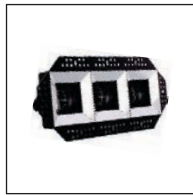

R31 (TRIMLESS)



R32 (TRIMLESS)



R33 (TRIMLESS)

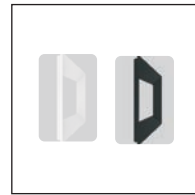

B26 (FRAME)

DEEP RECESSED EYEBALL / WALL WASHER SERIES

PG. NO. : 80-87



PRO-123 (8W)



R35



R36



R37

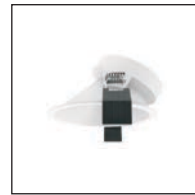

R38 (WALL WASHER)



R39 (WALL WASHER)



R40 (WALL WASHER)



R43



R44



R45



R47 (WALL WASHER)

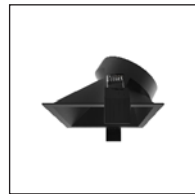

R48 (WALL WASHER)



R49 (WALL WASHER)



PRO-124 (13W)



R35



R36



R37



R38 (WALL WASHER)



R39 (WALL WASHER)



R40 (WALL WASHER)



R43



R44



R45



R47 (WALL WASHER)

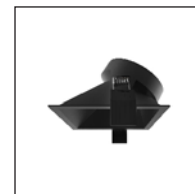

R48 (WALL WASHER)



R49 (WALL WASHER)

## CHROME REFLECTOR WALL WASHER SERIES

PG. NO. : 88-89



PRO-124 (13W)



R16



R16 (TRIMLESS)



R18



R18 (TRIMLESS)

## LED SPOT LIGHT SERIES

PG. NO. : 90-93



PRO-126 (13W)



PRO-129 (8W)  
(Trimless)



PRO-130 (8.7W)

## LED SPOT LIGHT SERIES 5°

PG. NO. : 94-95



PRO-131 (7W)



PRO-132 (7W)

## LED SPOT LIGHT SERIES

PG. NO. : 96-119



PRO-135 (6.2W/8.9W)



PRO-141 (6.2W/8.9W)



PRO-151 (7W/10W)



PRO-142 (6.9W/10W/15W)



PRO-143A (30W)



PRO-143 (38W)



PRO-155 (9.3W/13.8W)



PRO-156 (14W)



PRO-160 (6.2W)



PRO-161 (13W)



PRO-162 (13W)



PRO-164 (13W)



PRO-165 (13W)



PRO-171 (13W)



PRO-172 (13W)



PRO-174 (13W)

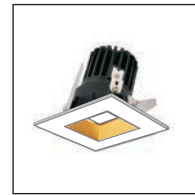

PRO-175 (13W)



PRO-181 (15W)

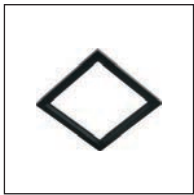

F1 (FRAME PRO-181)

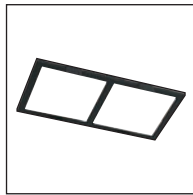

F2 (FRAME PRO-181)

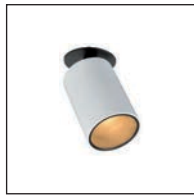

PRO-183 (9.3W/13.3W)



PRO-185 (9.3W/13.3)



PRO-186 (11W)



PRO-187 (13W)



PRO-190 (9W)



PRO-192 (17W)



PRO-194 (52W)



PRO-196 (9W)



PRO-198 (9W)



PRO-205 (2x5W)



PRO-206 (40W)



PRO-207 (40W)

## LED TRIMLESS CIRCLE & LINEAR SPOT LIGHT SERIES

PG. NO. : 122-125



PRO-213 (12x2.2W)



PRO-214 (24x2.2W)



PRO-217 (3x6.2W)



PRO-219 (7x6.2W)

## LED FIND ME SPOT LIGHT SERIES

PG. NO. : 126-127



PRO-231 (3W) TRIMLESS



PRO-232 (3W) WITH RIM



PRO-234 (10W) TRIMLESS



PRO-235 (10W) WITH RIM

## LED TRIMLESS DEEP ANTI-GLARE ADJUSTABLE LIGHT SERIES

PG. NO. : 128-131



PRO-237 (5W)



PRO-238 (9W)



PRO-239 (14W)

## LED SURFACE LIGHT SERIES

PG. NO. : 132-137



PRO-301 (15W)



PRO-302 (2x19W)



PRO-307 (8W)



PRO-308 (2x8W)



PRO-304 (7W)



PRO-305 (10W)



PRO-306 (10W)



PRO-310 (15W)



PRO-312 (15W)

**LED SURFACE LIGHT SERIES**

PG. NO. : 132-137



PRO-314 (11W)



PRO-315 (4W)

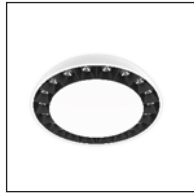

PRO-317 (15W)



PRO-320 (7W)

**OUTDOOR CONCEALED FOOT/STEP LIGHT - IP65**

PG. NO. : 138-139



PRO-341 (2.2W)



PRO-351 (1W)

**OUTDOOR SURFACE CEILING LIGHT - IP65**

PG. NO. : 142



PRO-645 (12W)

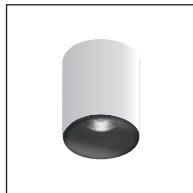

PRO-646 (24W)

**OUTDOOR ASYMMETRIC SURFACE CEILING WALL WASHER - IP65**

PG. NO. : 143



PRO-647 (10W)



PRO-648 (18W)



**OUTDOOR IN-GROUND LIGHT - IP67**

PG. NO. : 144-145



PRO-664 (10W)



PRO-665 (10W)

**OUTDOOR FLOOD LIGHT - 1 DEGREE - IP67**

PG. NO. : 146-147



PRO-670 (10W)

**OUTDOOR CONCEALED DIFFUSED STEP LIGHT - IP65**

PG. NO. : 148



PRO-672 (3W)



PRO-673 (3W)

**OUTDOOR SURFACE SPOT PROJECTION LIGHT - IP66**

PG. NO. : 149



PRO-677 (10W)



PRO-678 (18W)



S1 (SPIKE)



S2 (TREE BELT)



PRO-251 (10W/MTR)



PRO-252 (12W/MTR)

**OUTDOOR DOT FREE RIGID LINES SERIES - IP67**



PRO-257 (10W/Mtr)  
Rigid Linear Light

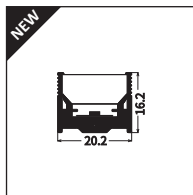

AL1 (1Mtr)  
Aluminium Profile Base  
Suitable for PRO-257

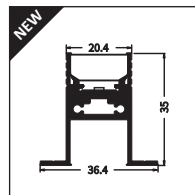

AL2 (1Mtr) - INGROUND  
Aluminium Profile Base  
Suitable for PRO-257

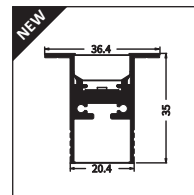

AL2 (1Mtr) CONCEALED  
Aluminium Profile Base  
Suitable for PRO-257

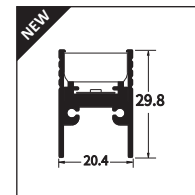

AL3 (1Mtr)  
Aluminium Profile Base  
Suitable for PRO-257

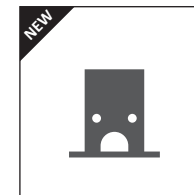

AL2 (ENDCAP)  
Inground & Concealed  
Suitable for AL2 Profile

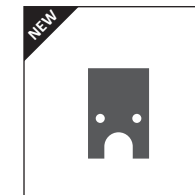

AL3 (ENDCAP)  
Suitable for AL3 Profile



AL9 (CONNECTOR)  
Male/Female Connector  
Suitable for PRO-257



PRO-258 (15W/Mtr)  
Rigid Linear Light

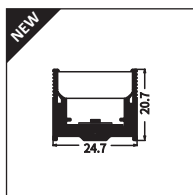

AL4 (1Mtr)  
Aluminium Profile Base  
Suitable for PRO-258

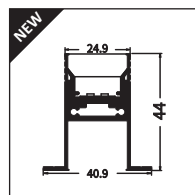

AL5 (1Mtr) - INGROUND  
Aluminium Profile Base  
Suitable for PRO-258

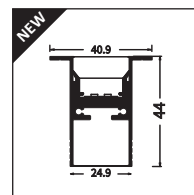

AL5 (1Mtr) CONCEALED  
Aluminium Profile Base  
Suitable for PRO-258

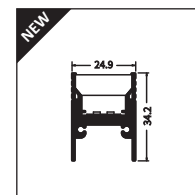

AL6 (1Mtr)  
Aluminium Profile Base  
Suitable for PRO-258

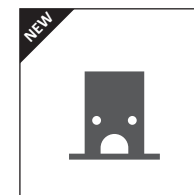

AL5 (ENDCAP)  
Inground & Concealed  
Suitable for AL5 Profile

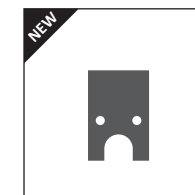

AL6 (ENDCAP)  
Suitable for AL6 Profile



AL9 (CONNECTOR)  
Male/Female Connector  
Suitable for PRO-258



PRO-259 (30W/Mtr)  
Rigid Linear Light

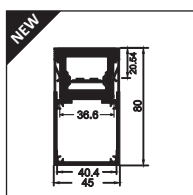

AL7 (1Mtr)  
Aluminium Profile Base  
Suitable for PRO-259

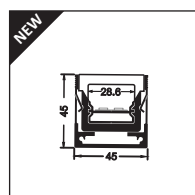

AL8 (1Mtr)  
Aluminium Profile Base  
Suitable for PRO-259

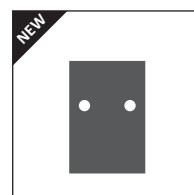

AL7 (ENDCAP)  
Inground & Concealed  
Suitable for AL7 Profile

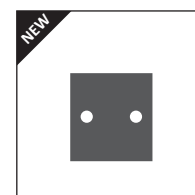

AL8 (ENDCAP)  
Suitable for AL8 Profile



AL10 (CONNECTOR)  
Male/Female Connector  
Suitable for PRO-259



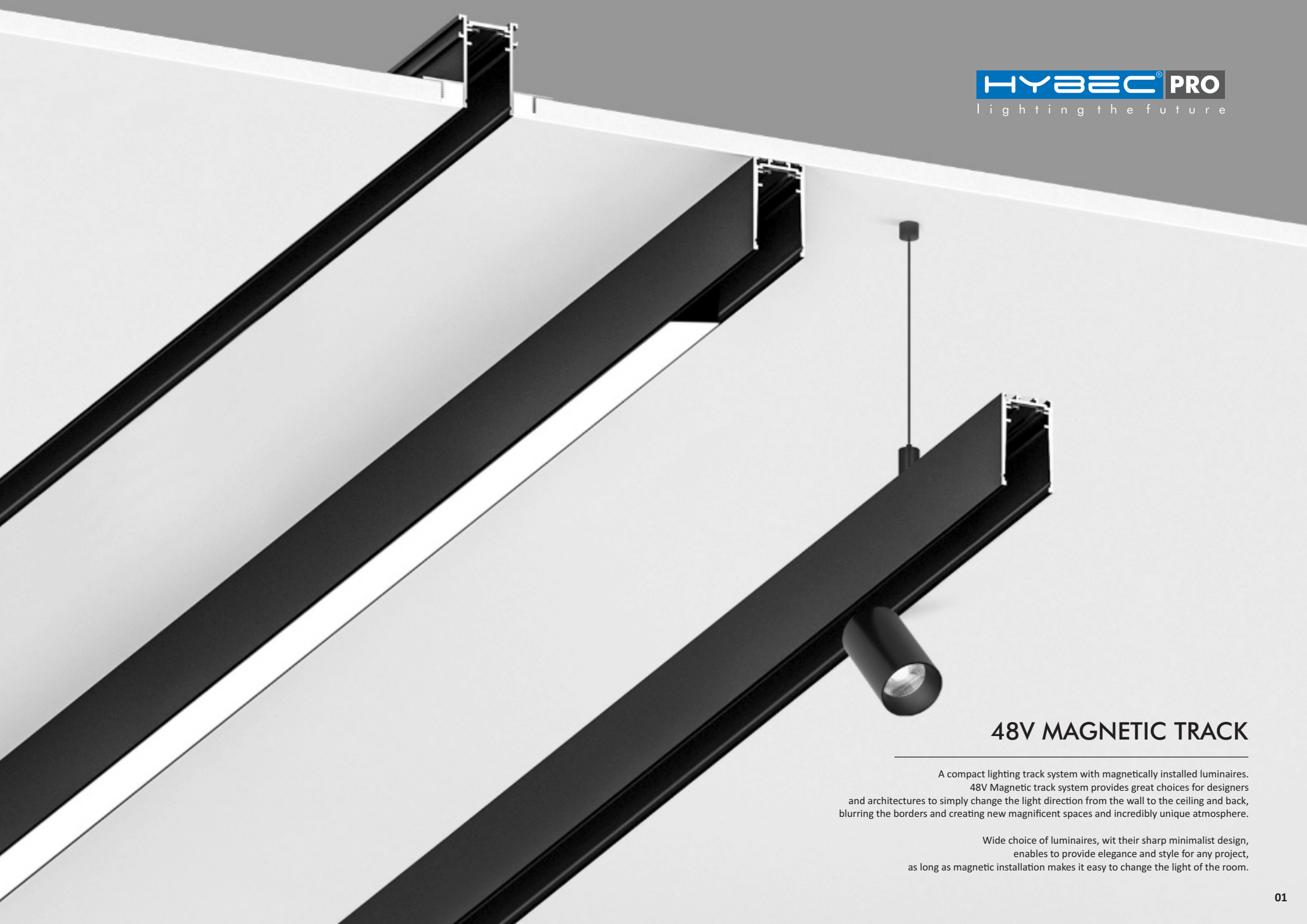

## 48V MAGNETIC TRACK

A compact lighting track system with magnetically installed luminaires. 48V Magnetic track system provides great choices for designers and architectures to simply change the light direction from the wall to the ceiling and back, blurring the borders and creating new magnificent spaces and incredibly unique atmosphere.

Wide choice of luminaires, with their sharp minimalist design, enables to provide elegance and style for any project, as long as magnetic installation makes it easy to change the light of the room.



## DISTINCTIVE FEATURES

State-of-the-art compact 48V track system allows changing the number of luminaires and their position on the track. A luminaire is installed at any place and can be easily moved along the track. A special mechanical button fixator provides reliable fastening of the luminaire on the track. All it takes is assembling the track during repairs, light fixtures can be installed when the repairs are finished. This helps to avoid such mistakes as insufficient room lighting or, on the contrary, glare.

## ANY LENGTH AND SHAPE

Track can be cut off anywhere with pinpoint precision. Tracks can be easily and seamlessly coupled. This allows to assemble a track system of any length and configuration. One adapter with a power lead is sufficient to connect a 20-meter long track with a load up to 480 Watts.

## OPERATION

The system supports DALI Lighting Control. This allows controlling each light fixture individually or a group of light fixtures at once, as well as creating custom lighting scenarios: you can time the lights to switch on and off as desired. Wireless Bluetooth control via a smartphone is available.

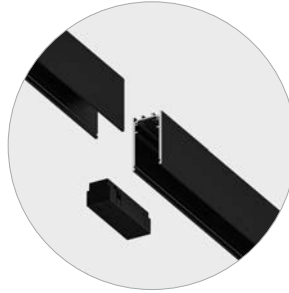

The track can be cut off anywhere with pinpoint precision.  
Tracks can be easily and seamlessly coupled



A special mechanical button fixator provides reliable fastening of the luminaire on the track.

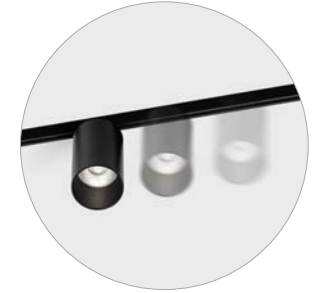

The luminaries can be installed at any place and can be easily moved along the track



Low Voltage Lighting System.



Only once power lead is required to connect the track system.  
Luminaires are cordless,  
power feeds directly through the track.



Precise contact with the conductive path.  
Low-voltage system is safe even to the touch.

## RECESSED TRIM-LESS TRACK INSTALLATION STEP BY STEP

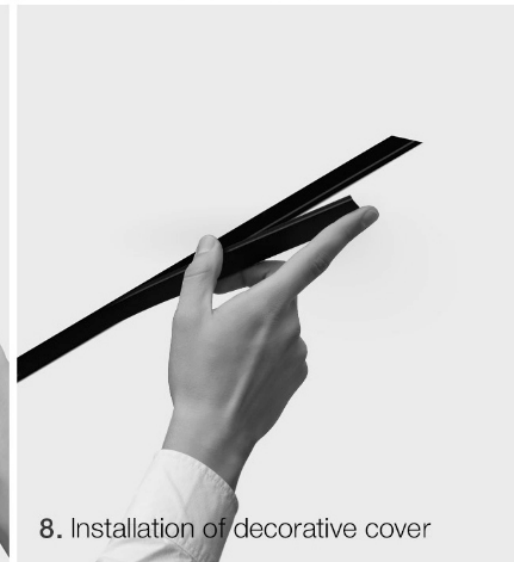
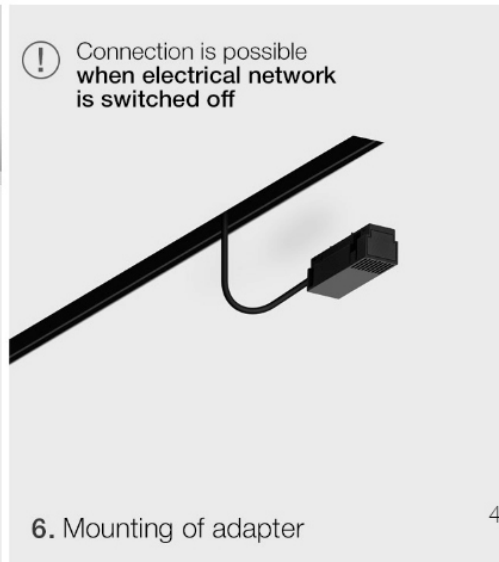
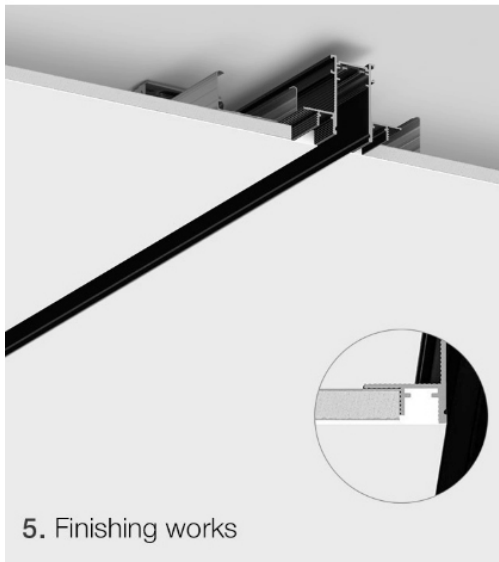
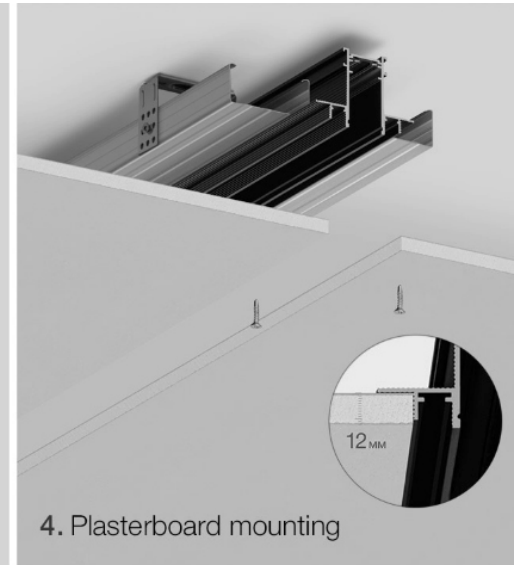
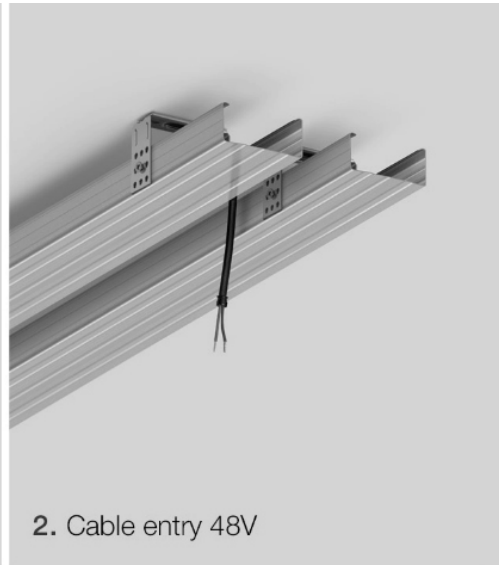
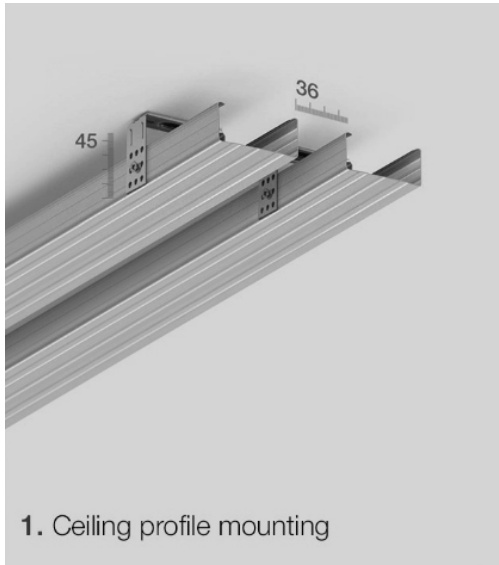

**INSTALLATION DRAWING**

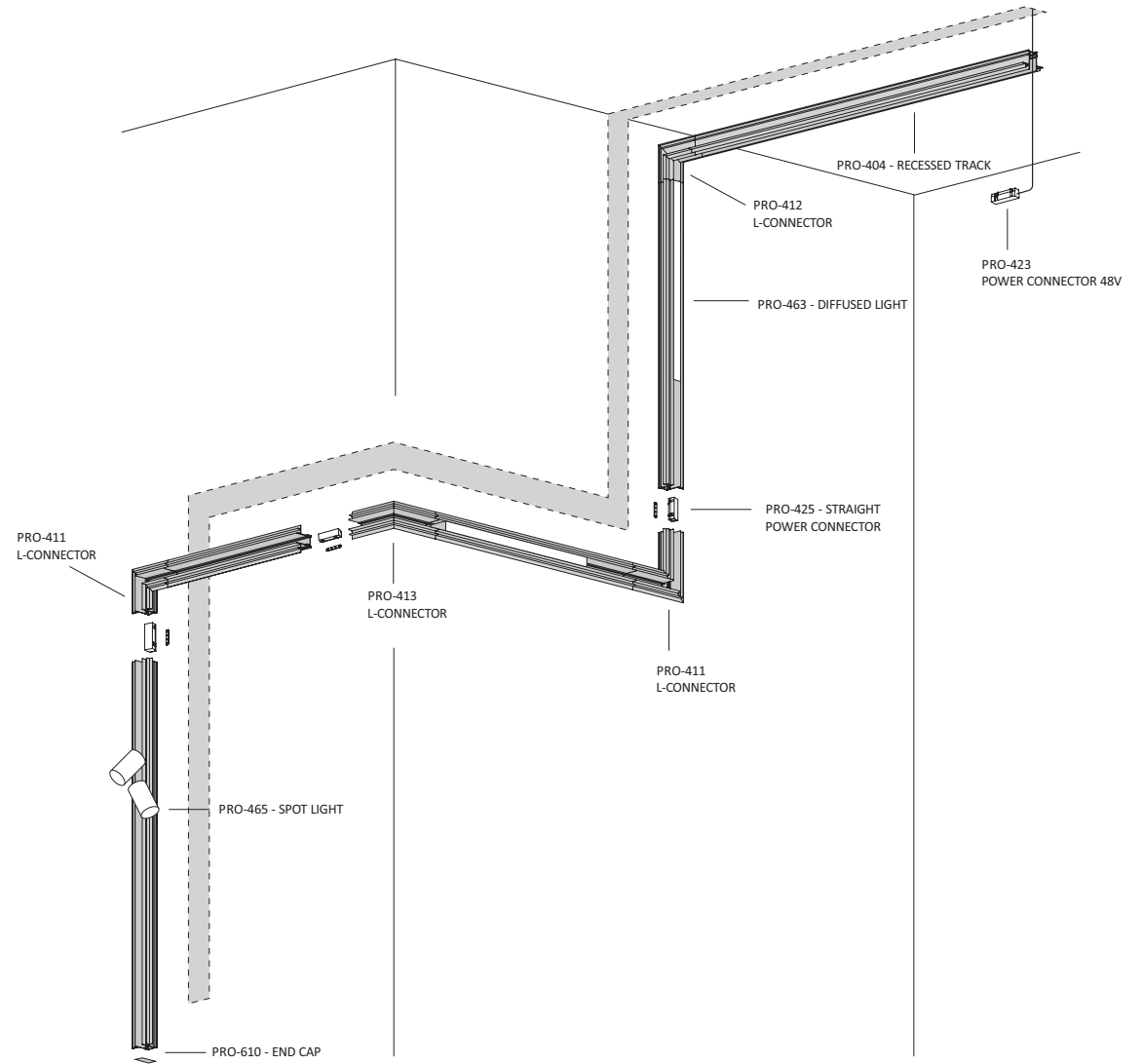
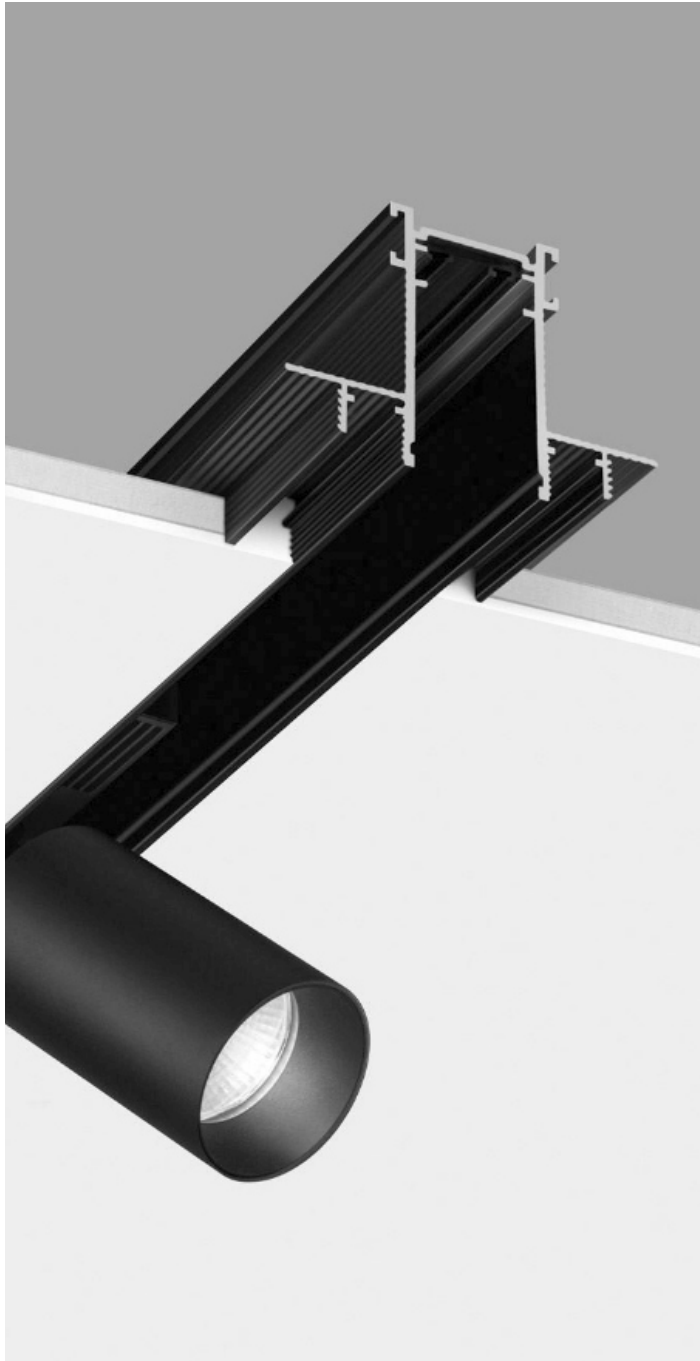





## 48V MAGNETIC TRACK SERIES

### RECESSED

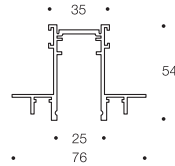

### RECESSED TRACK - TRIMLESS

Model No.	Body Colour	Track Size
PRO-401	Black	0.5mtr
PRO-402	Black	1mtr
PRO-403	Black	1.5mtr
PRO-404	Black	2mtr

### SURFACE

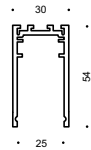

### SURFACE TRACK

Model No.	Body Colour	Track Size
PRO-601	Black	1mtr
PRO-602	Black	1.5mtr
PRO-603	Black	2mtr

### SUSPENSION KIT PRO-615



### TRACK PATTI COVER PRO-428 1mtr PRO-429 2mtr

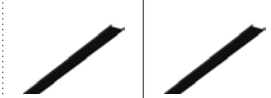

### END CAP PRO-610



### DV 48V CONNECTORS (CURRENT)

#### PRO-423



#### PRO-425

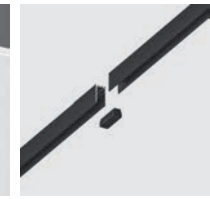

#### PRO-427

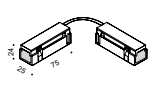

### L-CONNECTORS - RECESSED

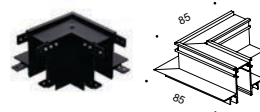

PRO-411

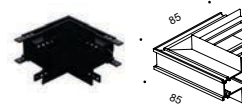

PRO-412

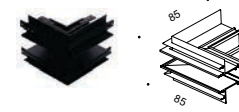

PRO-413

### L-CONNECTOR - SURFACE



PRO-611





## DC 48V TRACK SPOT

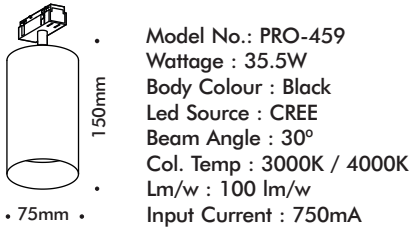
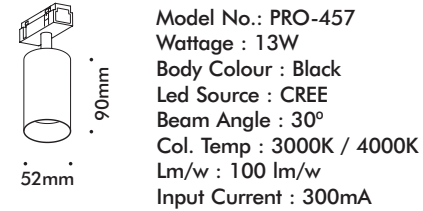
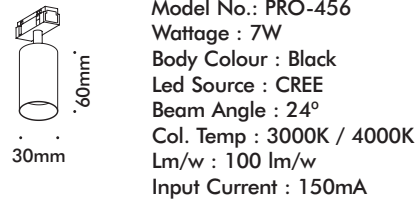
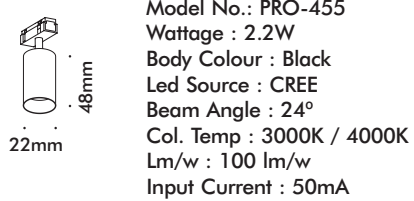

## DC 42V TRACK SPOT (0-10 Analog Dimming)

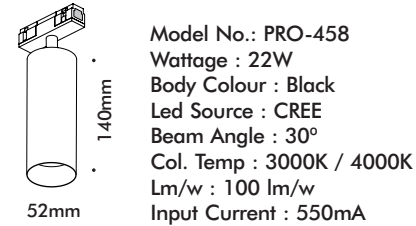
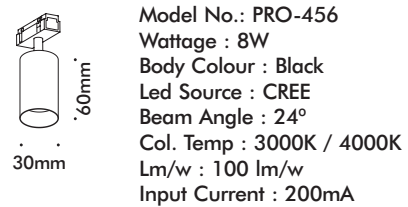

## DC 48V TRACK SPOT (DALI Dimming)

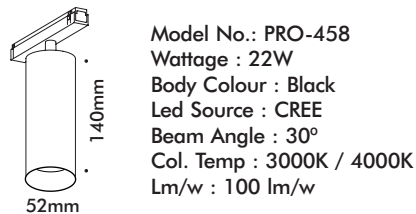
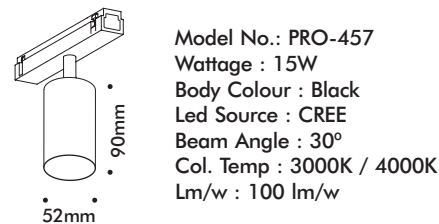
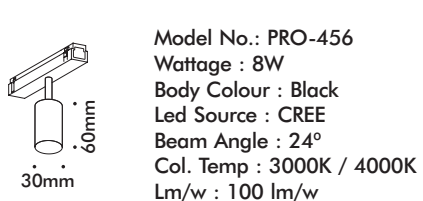

# LENGHT OF SUSPENSION

HEIGHT ADJUSTABLE





### DC 48V DUAL TRACK SPOT

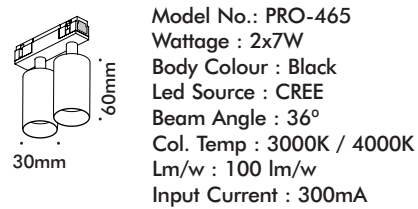
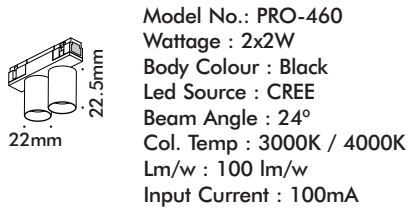

### DC 48V HANGING LIGHT

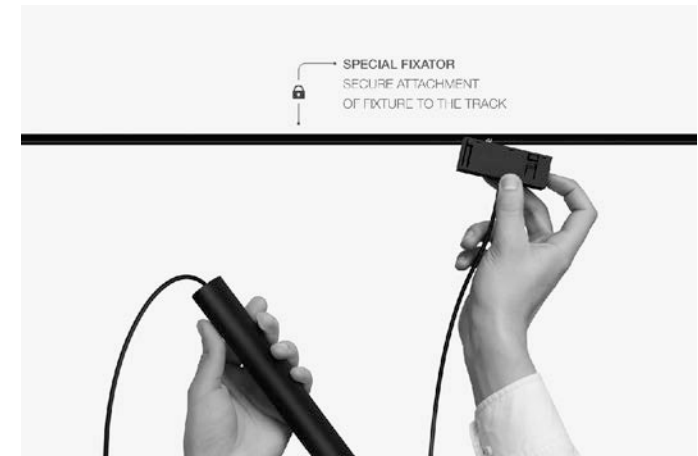
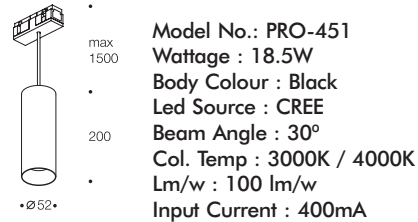
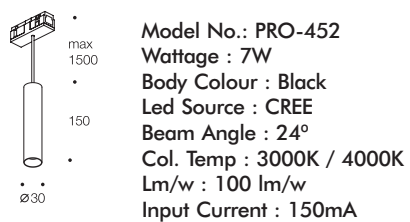

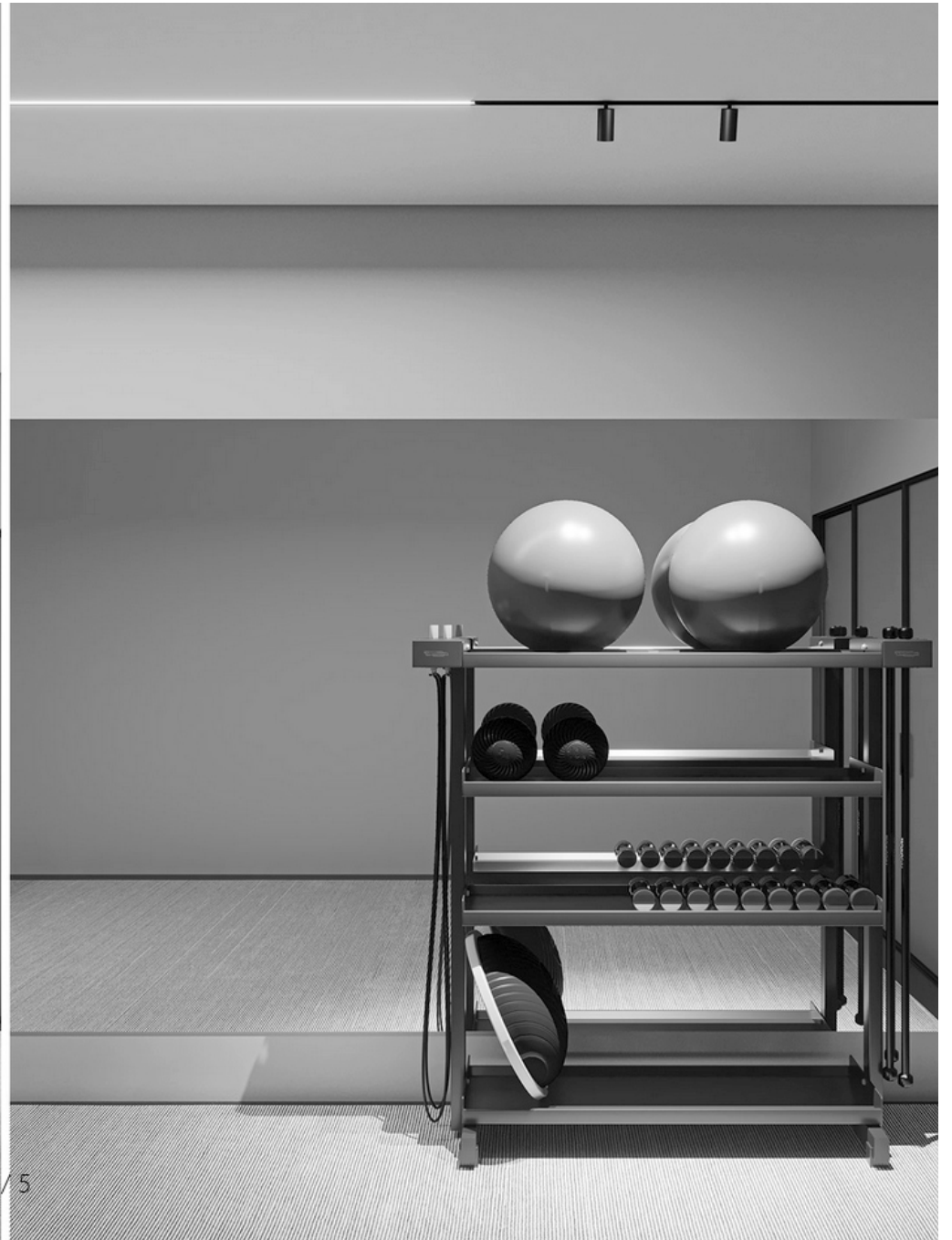

## DC 48V DIFFUSER LIGHT

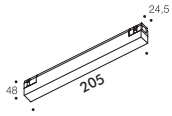

Model No.: PRO-461  
 Wattage : 5W  
 Body Colour : Black  
 Led Source : Bridgelux  
 Beam Angle : 120°  
 Col. Temp : 3000K / 4000K  
 Lm/w : 100 lm/w  
 Input Current : 100mA

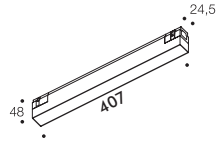

Model No.: PRO-462  
 Wattage : 10W  
 Body Colour : Black  
 Led Source : Bridgelux  
 Beam Angle : 120°  
 Col. Temp : 3000K / 4000K  
 Lm/w : 100 lm/w  
 Input Current : 200mA

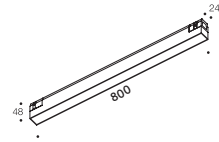

Model No.: PRO-463  
 Wattage : 18W  
 Body Colour : Black  
 Led Source : Bridgelux  
 Beam Angle : 120°  
 Col. Temp : 3000K / 4000K  
 Lm/w : 100 lm/w  
 Input Current : 400mA

## DC 42V DIFFUSER LIGHT (0-10 Analog Dimming)

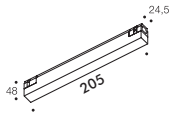

Model No.: PRO-461  
 Wattage : 8W  
 Body Colour : Black  
 Led Source : Bridgelux  
 Beam Angle : 120°  
 Col. Temp : 3000K / 4000K  
 Lm/w : 100 lm/w  
 Input Current : 200mA

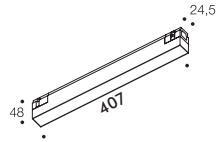

Model No.: PRO-462  
 Wattage : 14W  
 Body Colour : Black  
 Led Source : Bridgelux  
 Beam Angle : 120°  
 Col. Temp : 3000K / 4000K  
 Lm/w : 100 lm/w  
 Input Current : 350mA

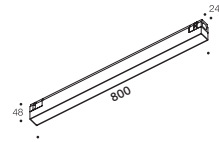

Model No.: PRO-463  
 Wattage : 21W  
 Body Colour : Black  
 Led Source : Bridgelux  
 Beam Angle : 120°  
 Col. Temp : 3000K / 4000K  
 Lm/w : 100 lm/w  
 Input Current : 500mA

## DC 48V DIFFUSER LIGHT (DALI Dimming)

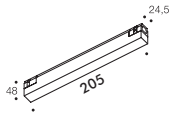

Model No.: PRO-461  
 Wattage : 8W  
 Body Colour : Black  
 Led Source : Bridgelux  
 Beam Angle : 120°  
 Col. Temp : 3000K / 4000K  
 Lm/w : 100 lm/w

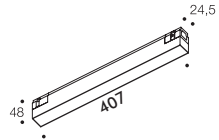

Model No.: PRO-462  
 Wattage : 14W  
 Body Colour : Black  
 Led Source : Bridgelux  
 Beam Angle : 120°  
 Col. Temp : 3000K / 4000K  
 Lm/w : 100 lm/w

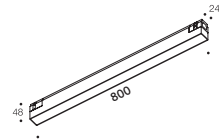

Model No.: PRO-463  
 Wattage : 21W  
 Body Colour : Black  
 Led Source : Bridgelux  
 Beam Angle : 120°  
 Col. Temp : 3000K / 4000K  
 Lm/w : 100 lm/w

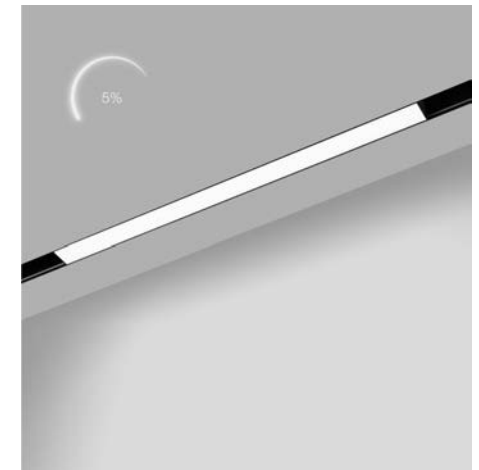
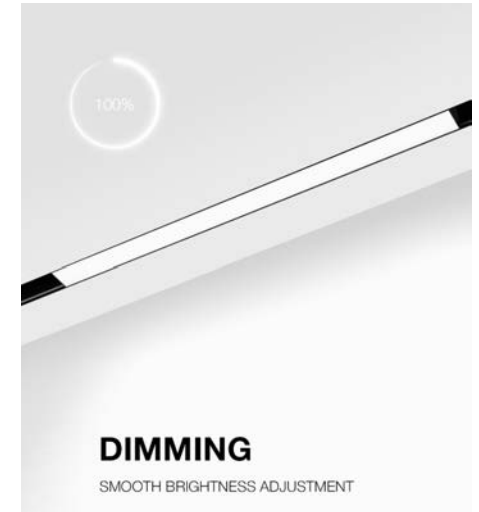







**HYBEC<sup>®</sup> PRO**

ighting the future

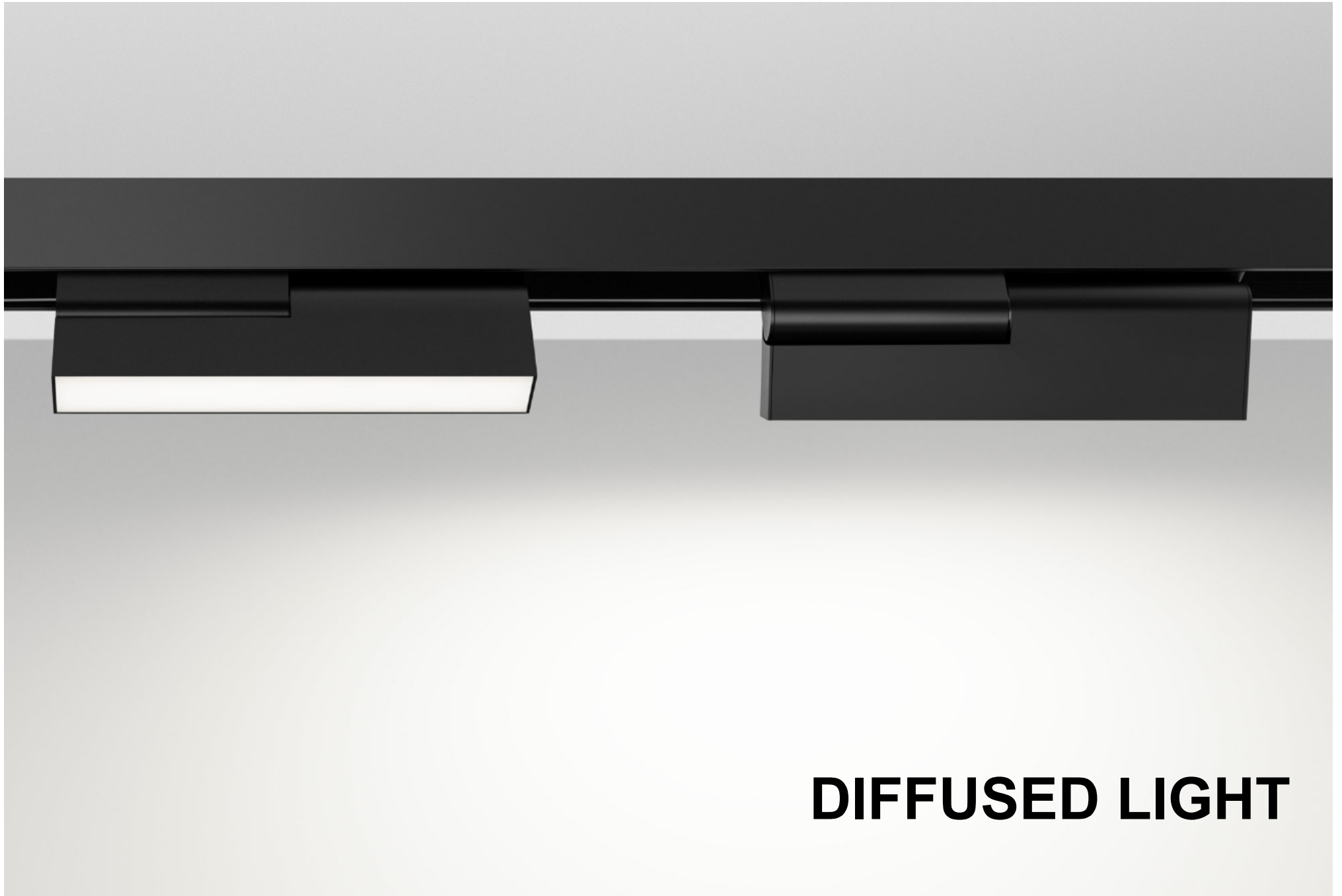

**DIFFUSED LIGHT**

## DC 42V DIFFUSED LIGHT - WALL WASHER (0-10 Analog Dimming)

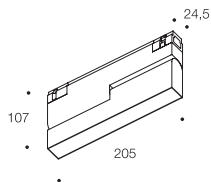

Model No.: PRO-464  
Wattage : 8W  
Body Colour : Black  
Led Source : Cree  
Beam Angle : 120°  
Col. Temp : 3000K / 4000K  
Lm/w : 100 lm/w  
Input Current : 200mA

## DC 48V DIFFUSED LIGHT - WALL WASHER (DALI Dimming)

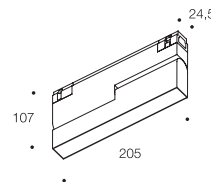

Model No.: PRO-464  
Wattage : 8W  
Body Colour : Black  
Led Source : Cree  
Beam Angle : 120°  
Col. Temp : 3000K / 4000K  
Lm/w : 100 lm/w

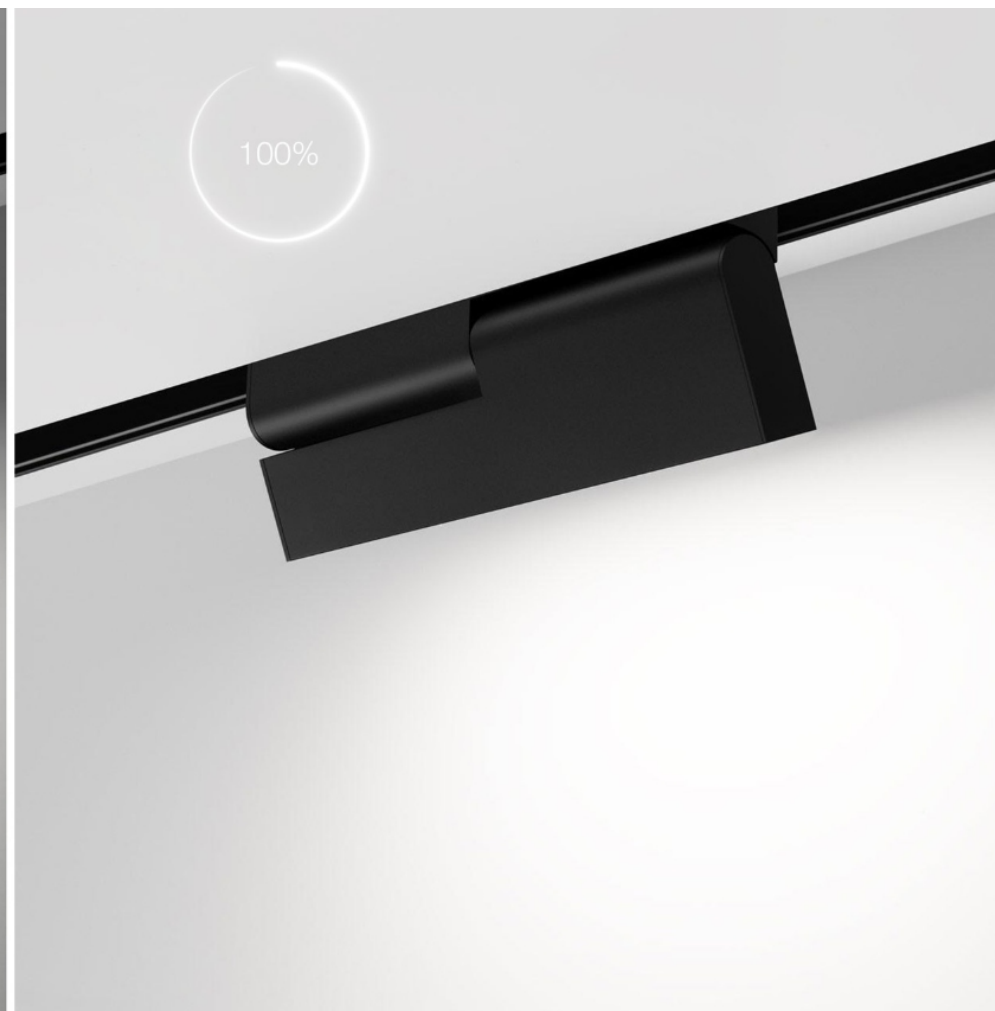





PRO-468

PRO-466

## DC 48V DIFFUSED LIGHT - L Shape

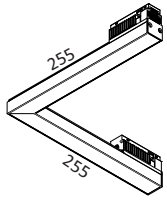

Model No.: PRO-466  
Wattage : 10W  
Body Colour : Black  
Led Source : Bridgelux  
Beam Angle : 120°  
Col. Temp : 3000K / 4000K  
Lm/w : 100 lm/w  
Input Current : 200mA

## DC 48V DIFFUSED LIGHT - L Shape

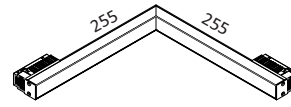

Model No.: PRO-468  
Wattage : 10W  
Body Colour : Black  
Led Source : Bridgelux  
Beam Angle : 120°  
Col. Temp : 3000K / 4000K  
Lm/w : 100 lm/w  
Input Current : 200mA







# **SUPER COMFORT LENS**

EVEN LIGHTING  
WITHOUT HALO OR DARK SPOTS

**DC 48V LINEAR SPOT LIGHT**

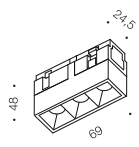

Model No.: PRO-471  
Wattage : 3.3W  
Body Colour : Black  
Led Source : Cree  
Beam Angle : 36°  
Col. Temp : 3000K / 4000K  
Lm/w : 100 lm/w  
Input Current : 100mA

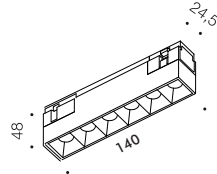

Model No.: PRO-472  
Wattage : 6.6W  
Body Colour : Black  
Led Source : Cree  
Beam Angle : 36°  
Col. Temp : 3000K / 4000K  
Lm/w : 100 lm/w  
Input Current : 150mA

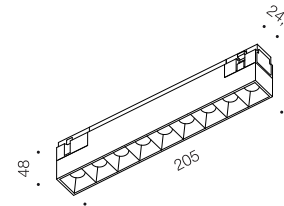

Model No.: PRO-473  
Wattage : 10W  
Body Colour : Black  
Led Source : Cree  
Beam Angle : 36°  
Col. Temp : 3000K / 4000K  
Lm/w : 100 lm/w  
Input Current : 200mA

**DC 42V LINEAR SPOT LIGHT (0-10 Analog Dimming)**

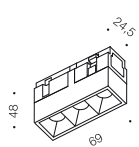

Model No.: PRO-471  
Wattage : 7W  
Body Colour : Black  
Led Source : Cree  
Beam Angle : 36°  
Col. Temp : 3000K / 4000K  
Lm/w : 100 lm/w  
Input Current : 200mA

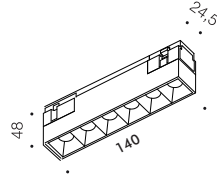

Model No.: PRO-472  
Wattage : 7W  
Body Colour : Black  
Led Source : Cree  
Beam Angle : 36°  
Col. Temp : 3000K / 4000K  
Lm/w : 100 lm/w  
Input Current : 200mA

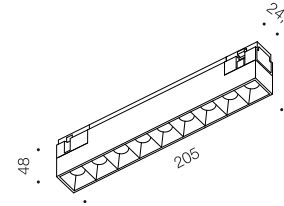

Model No.: PRO-473  
Wattage : 14W  
Body Colour : Black  
Led Source : Cree  
Beam Angle : 36°  
Col. Temp : 3000K / 4000K  
Lm/w : 100 lm/w  
Input Current : 350mA

**DC 48V LINEAR SPOT LIGHT (DALI Dimming)**

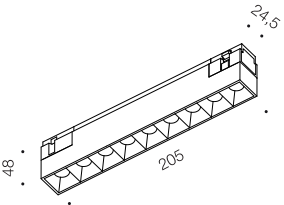

Model No.: PRO-473  
Wattage : 11W  
Body Colour : Black  
Led Source : Cree  
Beam Angle : 36°  
Col. Temp : 3000K / 4000K  
Lm/w : 100 lm/w



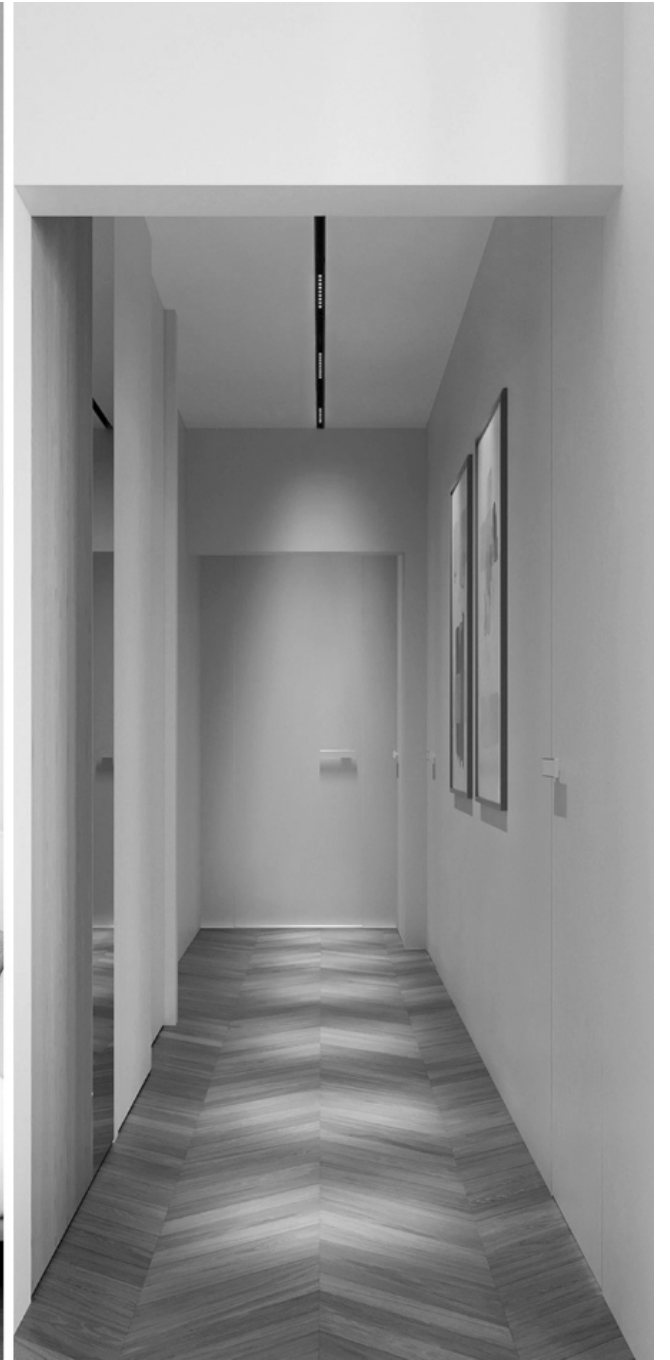

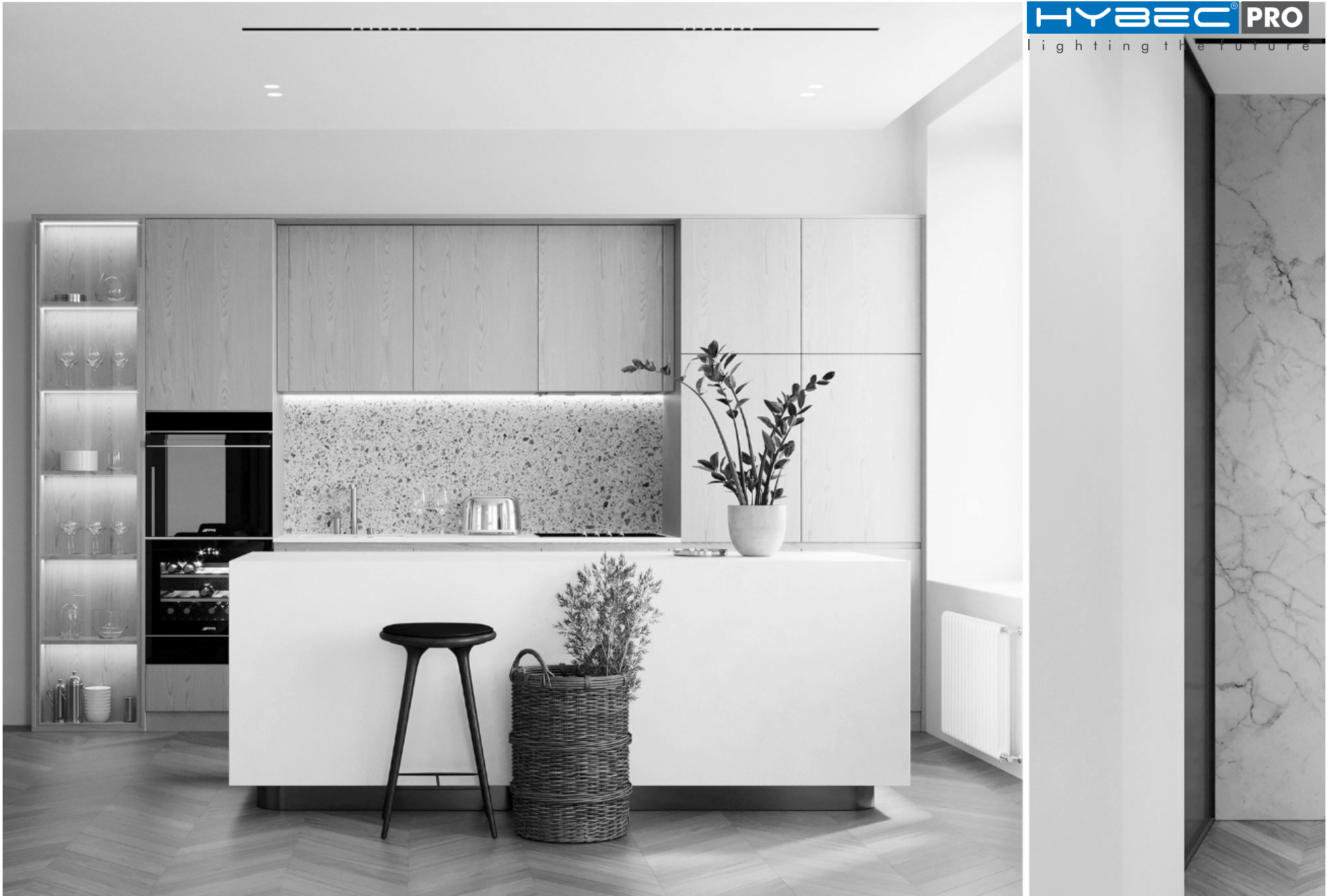



# ANTI-GLARE SCREEN

SHIELDS THE LIGHT SOURCE  
FROM THE LINE OF SIGHT ELIMINATING  
GLARE EFFECT ELIMINATED



## DC 48V LINEAR LIGHT - WALL WASHER

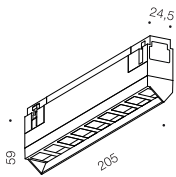

Model No.: PRO-475  
Wattage : 10W  
Body Colour : Black  
Led Source : Cree  
Beam Angle : 60°  
Col. Temp : 3000K / 4000K  
Lm/w : 100 lm/w  
Input Current : 200mA

## DC 48V LINEAR LIGHT - WALL WASHER (DALI Dimming)

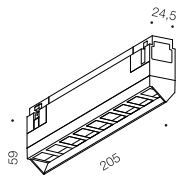

Model No.: PRO-475  
Wattage : 10W  
Body Colour : Black  
Led Source : Cree  
Beam Angle : 60°  
Col. Temp : 3000K / 4000K  
Lm/w : 100 lm/w



# WALLWASHER

EVEN LIGHTING OF WALLS



# **SUPER COMFORT LENS**

EVEN LIGHTING  
WITHOUT HALO OR DARK SPOTS

## DC 48V LINEAR LIGHT - WALL WASHER

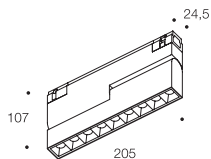

Model No.: PRO-477  
Wattage : 12W  
Body Colour : Black  
Led Source : Cree  
Beam Angle : 30°  
Col. Temp : 3000K / 4000K  
Lm/w : 100 lm/w  
Input Current : 250mA

## DC 48V LINEAR LIGHT - WALL WASHER (01-0 Analog Dimming)

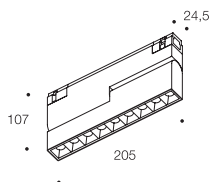

Model No.: PRO-477  
Wattage : 14W  
Body Colour : Black  
Led Source : Cree  
Beam Angle : 30°  
Col. Temp : 3000K / 4000K  
Lm/w : 100 lm/w

## DC 48V LINEAR LIGHT - WALL WASHER (DALI Dimming)

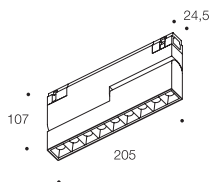

Model No.: PRO-477  
Wattage : 14W  
Body Colour : Black  
Led Source : Cree  
Beam Angle : 30°  
Col. Temp : 3000K / 4000K  
Lm/w : 100 lm/w





#### DISTINCTIVE FEATURES

Four dimming elements built in the core allow to change the shape of the light spot and make it square, triangle-shaped, or any other simple geometric shape. Edges of a light spot can be adjusted and made either well-defined or blurred with a focusing ring. The fixture is installed in any place on the track and moves along easily. Secure attachment of the fixtures to the track is ensured by a special mechanical button fixator.

#### LIGHT ICON

Light shaping tool for creating lighting images. A thin disk with an image applied on its surface is placed between the light source and the lens. When passing through it, the beam projects the image onto the surface. This allows to create custom light images: from a simple icon to a company logo.

#### CONTROL

This product line has models that support DALI Digital Protocol. This allows to control each luminaire individually or group them together: turn them on and off, dim.

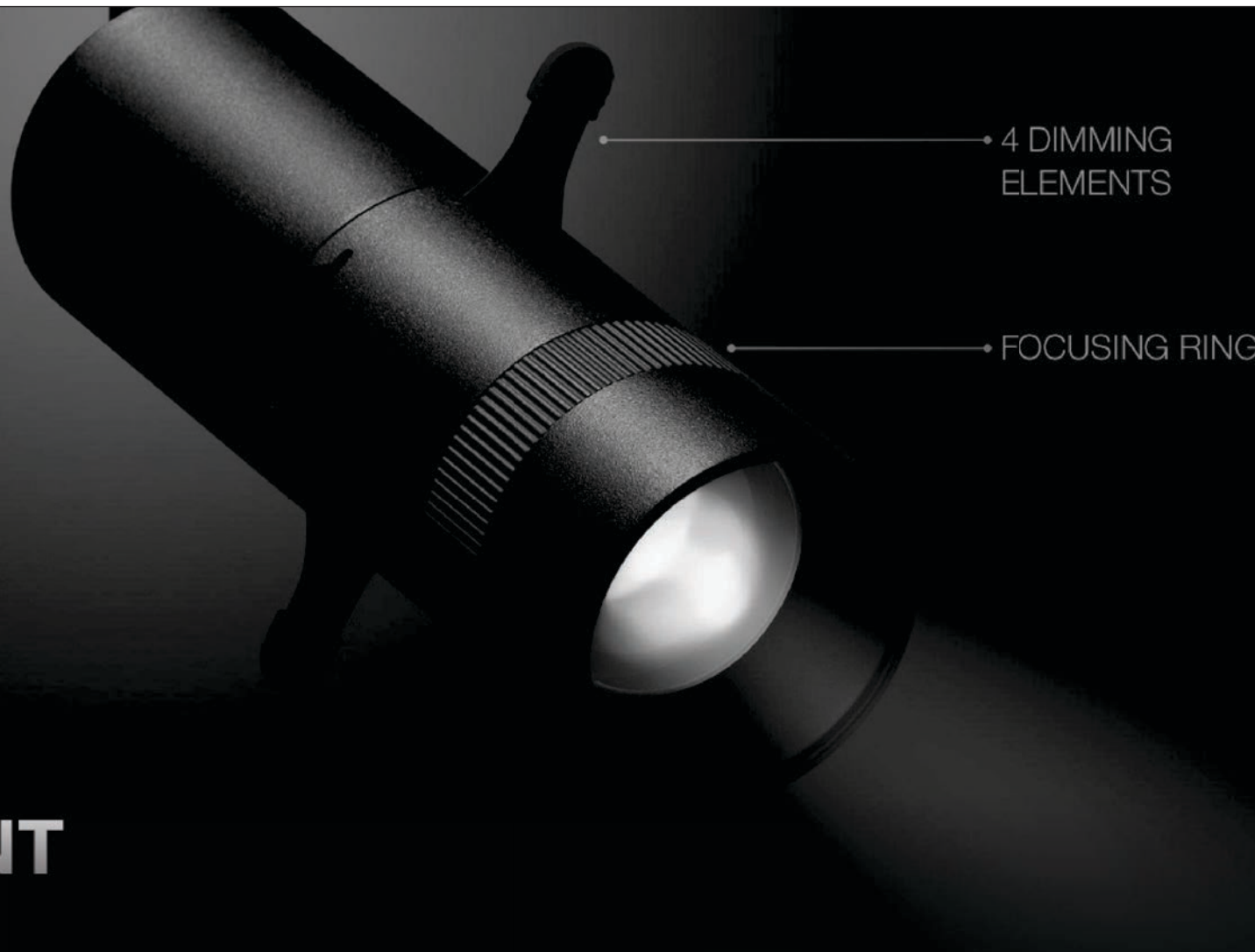

# EASY ADJUSTMENT

OF LIGHT SPOT

**HYBEC<sup>®</sup> PRO**  
lighting the future

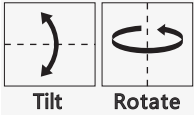

Tilt

Rotate

**SPECIAL FIXATOR**  
 SECURE ATTACHMENT  
 OF FIXTURE TO THE TRACK



NEW

**DC 48V MUSEUM LIGHT**

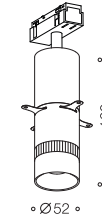

Model No.: PRO-480  
 Wattage : 7W  
 Body Colour : Black  
 Led Source : Cree  
 Beam Angle : 120°  
 Col. Temp : 3000K  
 Lm/w : 100 lm/w  
 Input Current : 200mA

NEW

**SURFACE MUSEUM LIGHT**

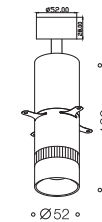

Model No.: PRO-320  
 Wattage : 7W  
 Body Colour : Black  
 Led Source : Cree  
 Beam Angle : 120°  
 Col. Temp : 3000K  
 Lm/w : 100 lm/w  
 Input Current : 200mA

**FOCUS ADJUSTMENT**



**SHAPE ADJUSTMENT**



## DC 48V SPHERE SPOT

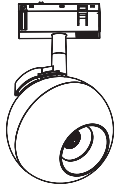

Model No.: PRO-481  
Wattage : 14W  
Body Colour : Black  
Led Source : Cree  
Beam Angle : 30°  
Col. Temp : 3000K / 4000K  
Lm/w : 100 lm/w  
Input Current : 350mA



# SUPER COMFORT LENS

NUMEROUS FACETS PROVIDE  
PURE AND EVEN LIGHTING



## DC 48V SPHERE SPOT - DIFFUSED

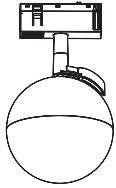

Model No.: PRO-482  
Wattage : 14W  
Body Colour : Black  
Led Source : Cree  
Beam Angle : 120°  
Col. Temp : 3000K / 4000K  
Lm/w : 100 lm/w  
Input Current : 350mA

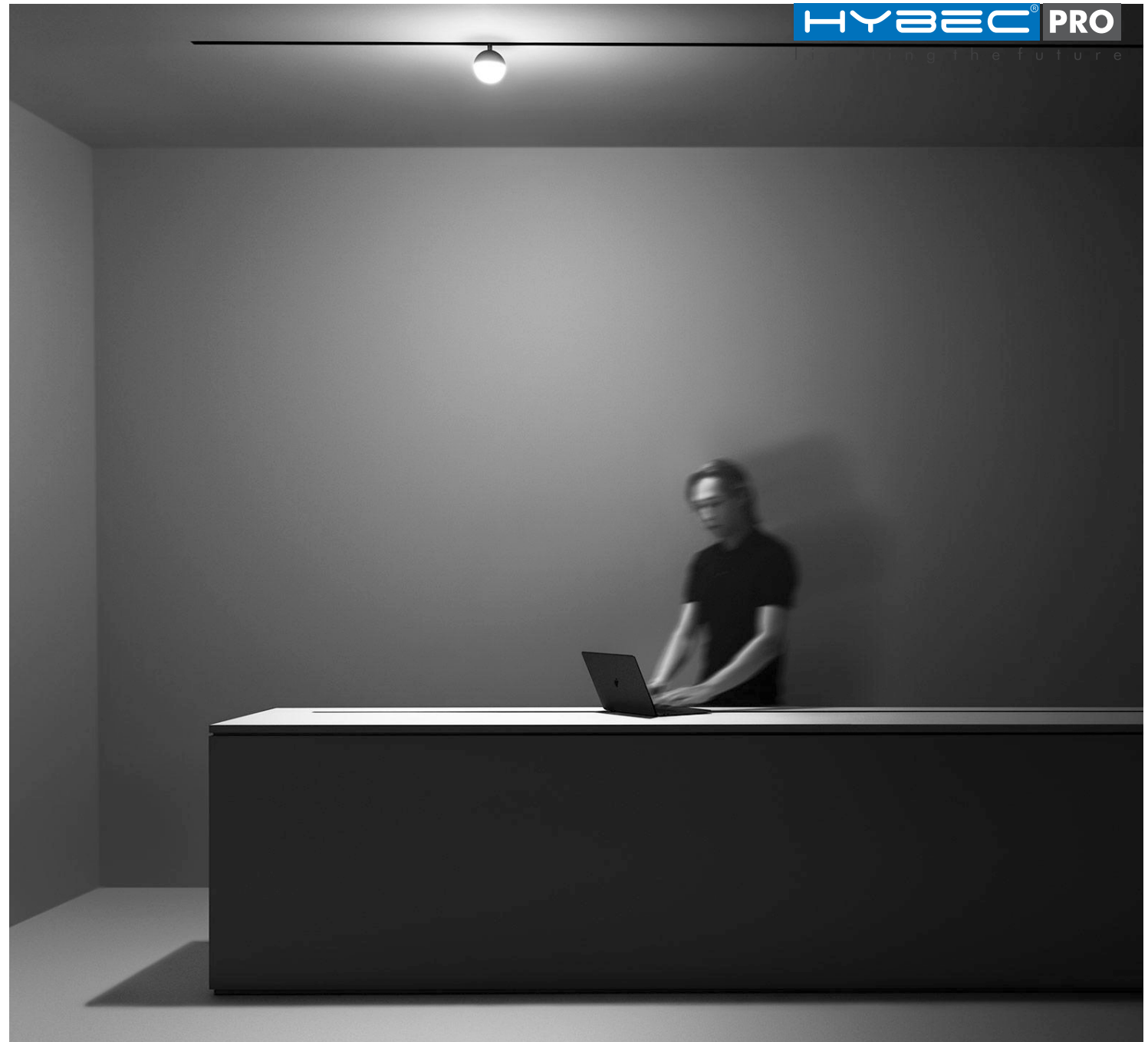
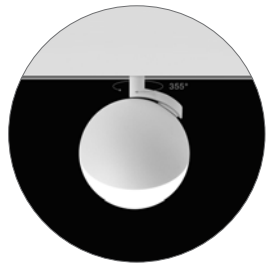

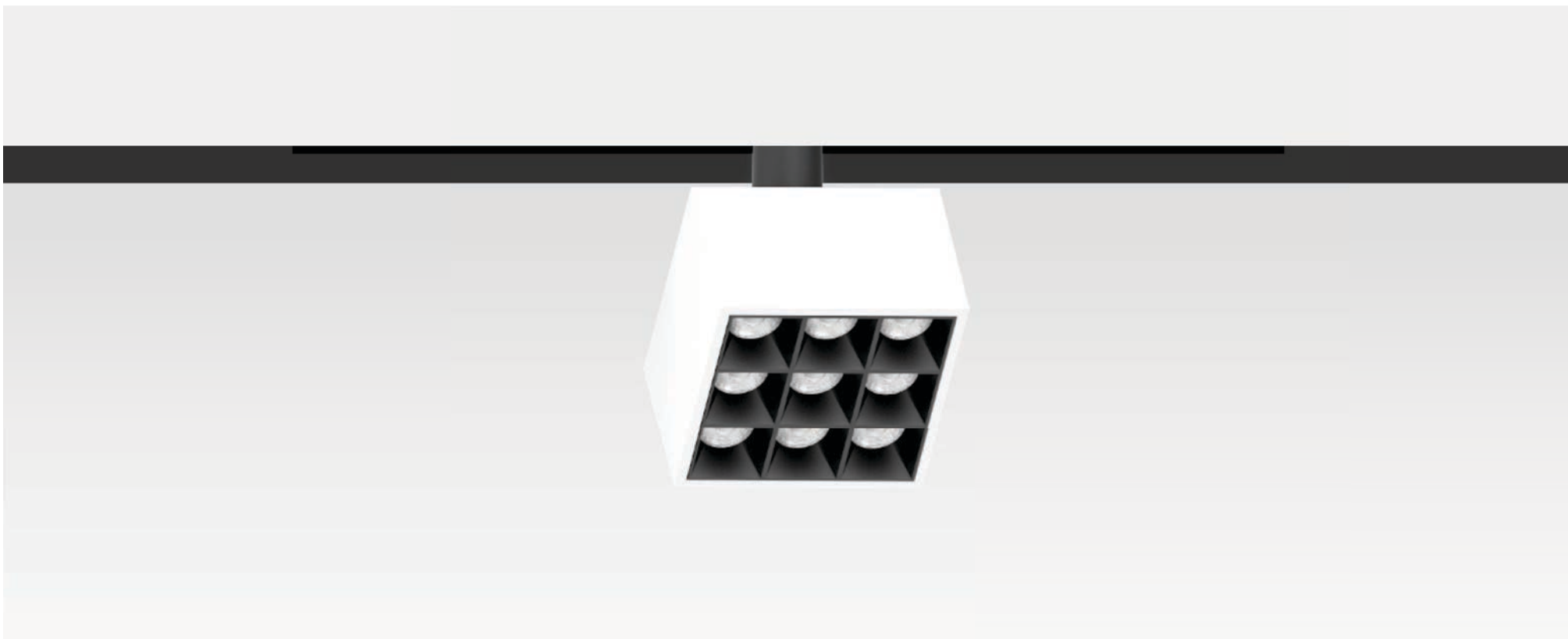

### DC 48V ANTI-GLARE SQUARE SHAPED SPOT

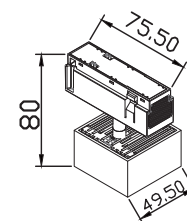

Model No.: PRO-483  
Wattage : 7W  
Body Colour : Black  
Led Source : Cree  
Beam Angle : 30°  
Col. Temp : 3000K / 4000K  
Lm/w : 100 lm/w  
Input Current : 350mA

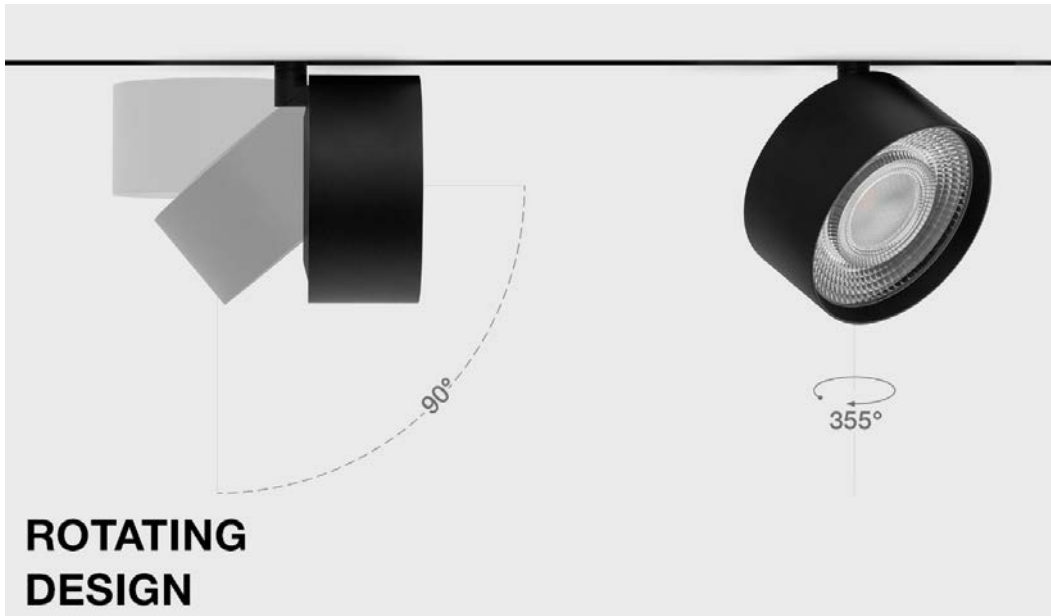

**ROTATING  
DESIGN**

**DC 48V CIRCULAR SPOT - WITH LENS**

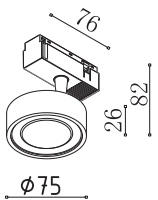

Model No.: PRO-484  
Wattage : 7W  
Body Colour : Black / Rose Gold  
Led Source : Cree  
Beam Angle : 24°  
Col. Temp : 3000K / 4000K  
Lm/w : 100 lm/w  
Input Current : 700mA



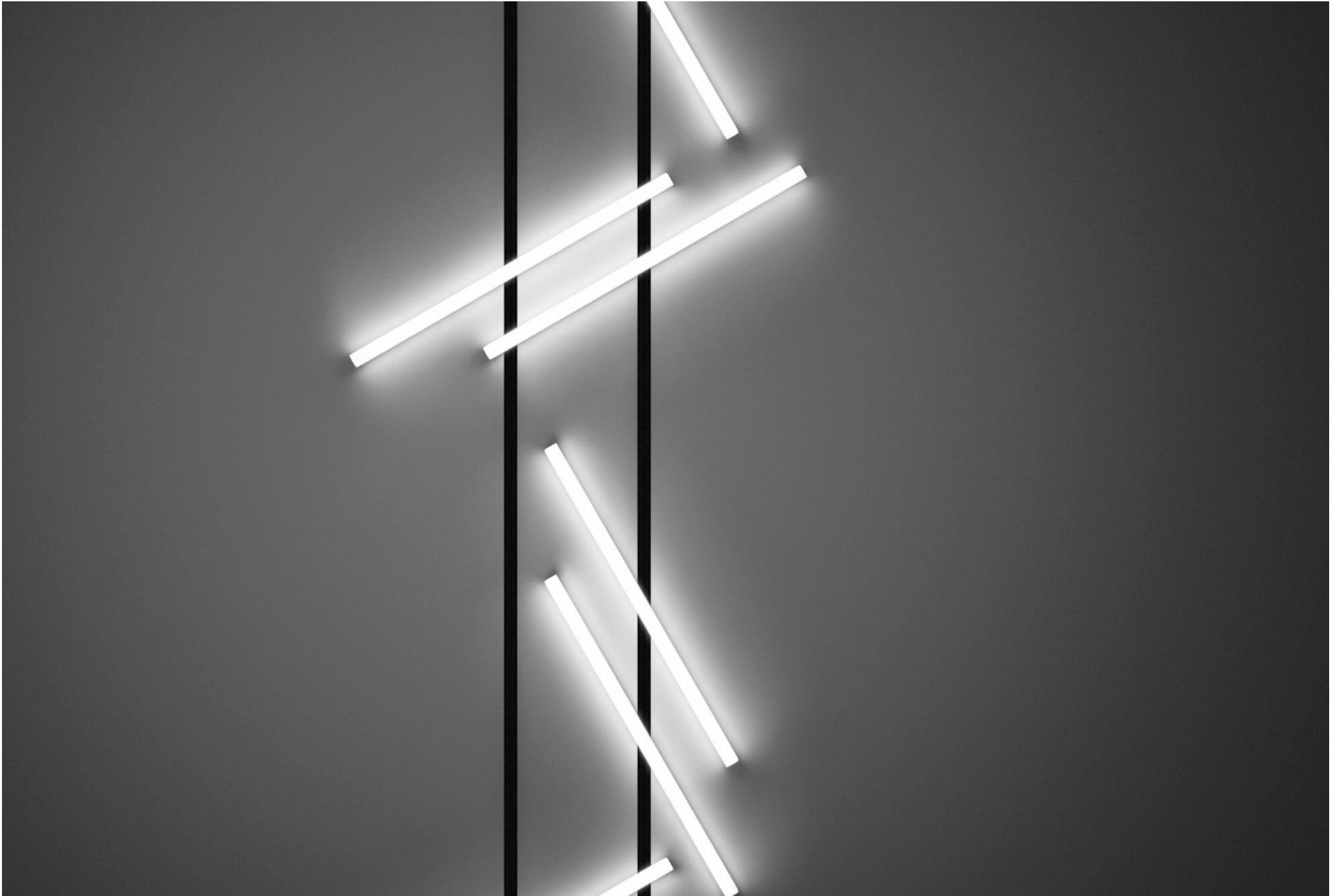

## DC 48V LINEAR LIGHT - TUBULAR

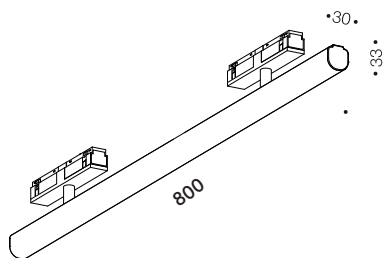

Model No.: PRO-488  
Wattage : 20W  
Body Colour : Black  
Led Source : Bridgelux  
Beam Angle : 120°  
Col. Temp : 3000K / 4000K  
Lm/w : 100 lm/w  
Input Current : 500mA

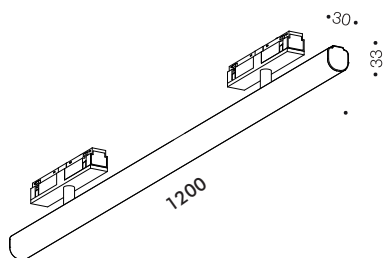

Model No.: PRO-489  
Wattage : 30W  
Body Colour : Black  
Led Source : Bridgelux  
Beam Angle : 120°  
Col. Temp : 3000K / 4000K  
Lm/w : 100 lm/w  
Input Current : 900mA





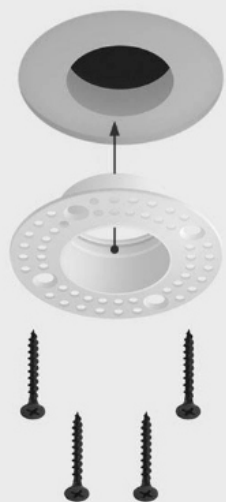

Trimless installation

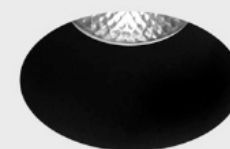

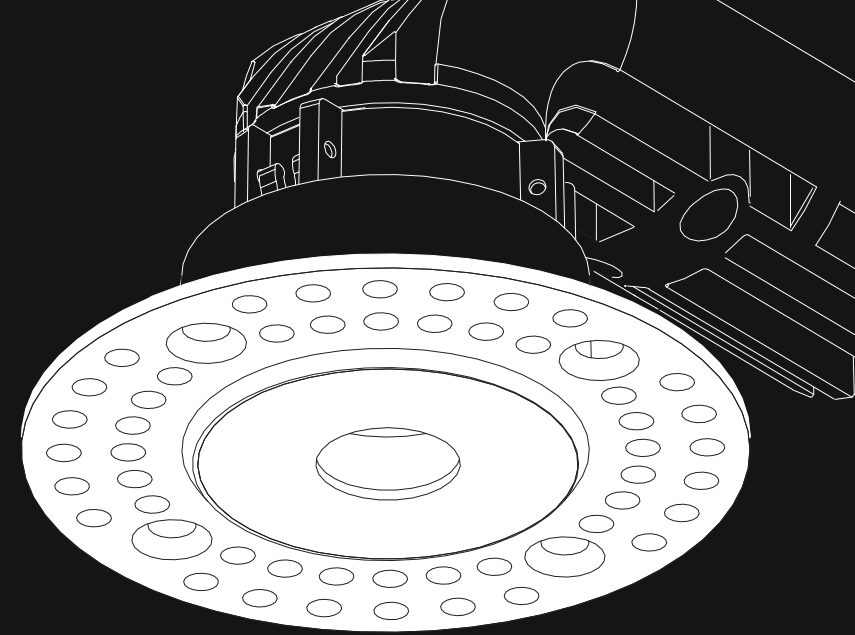

Light,  
the visible reminder of Invisible light.

**HYBEC<sup>®</sup> PRO**  
lighting the future

- Introducing,
- ▶ Minimal Dia of Luminaire,
  - ▶ Low Height &
  - ▶ Wide Spread Light.

## ULTRA WIDE LENS

UNIQUE STRUCTURE OF OPTICS GIVES WIDE 50° LIGHT ANGLE WITH MINIMAL DIAMETER OF LUMINARY.



## PATENTED RADIATOR FORM

SMALL MOUNTING DEPTH FOR  
EFFICIENT HEAT REMOVAL.



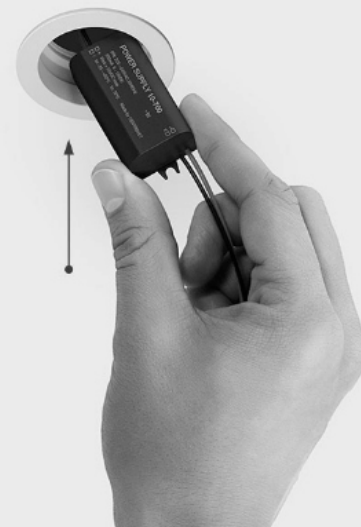

# 9W LOW HEIGHT LUMINARE

## DISTINCTIVE FEATURES

Minimalistic and modern design. Mounted flush with the ceiling.

Seamless transition between the luminaire and the ceiling due to concealed mounting technology.

Thus, the luminaire become an integral part of the interior. The series also features luminaires with a decorative trim.

## HEATSHINK

The unique design of the radiator is HYBEC PRO's most recent development (patented).

It provides effective heat dissipation, which is essential for high brightness luminaires, and allows the height of the ceilings to remain intact due to small installation depth (67 mm).

### Model No.: PRO-222

Material : Aluminium  
Body Colour : White / Black  
Power : 9W  
Light Source : CREE LED  
Col. Temp : 3000K / 4000K  
Beam Angle : 40°  
Current : 700mA.  
Product Size : Ø48x67mm  
Cut-Out Size : Ø44mm



### Model No.: PRO-222 + PF-04 (Trimless)

Material : Aluminium  
Body Colour : White / Black  
Power : 9W  
Light Source : CREE LED  
Col. Temp : 3000K / 4000K  
Beam Angle : 40°  
Current : 700mA.  
Product Size : Ø68x67mm  
Cut-Out Size : Ø39mm



### Model No.: PRO-229

Material : Aluminium  
Body Colour : White / Black  
Power : 9W  
Light Source : CREE LED  
Col. Temp : 3000K / 4000K  
Beam Angle : 40°  
Current : 700mA.  
Product Size : 48x48x67mm  
Cut-Out Size : 44x44mm



### Model No.: PRO-229 + PF-06 (Trimless)

Material : Aluminium  
Body Colour : White / Black  
Power : 9W  
Light Source : CREE LED  
Col. Temp : 3000K / 4000K  
Beam Angle : 40°  
Current : 700mA.  
Product Size : 68x68x67mm  
Cut-Out Size : 39x39mm



Optional Degree :

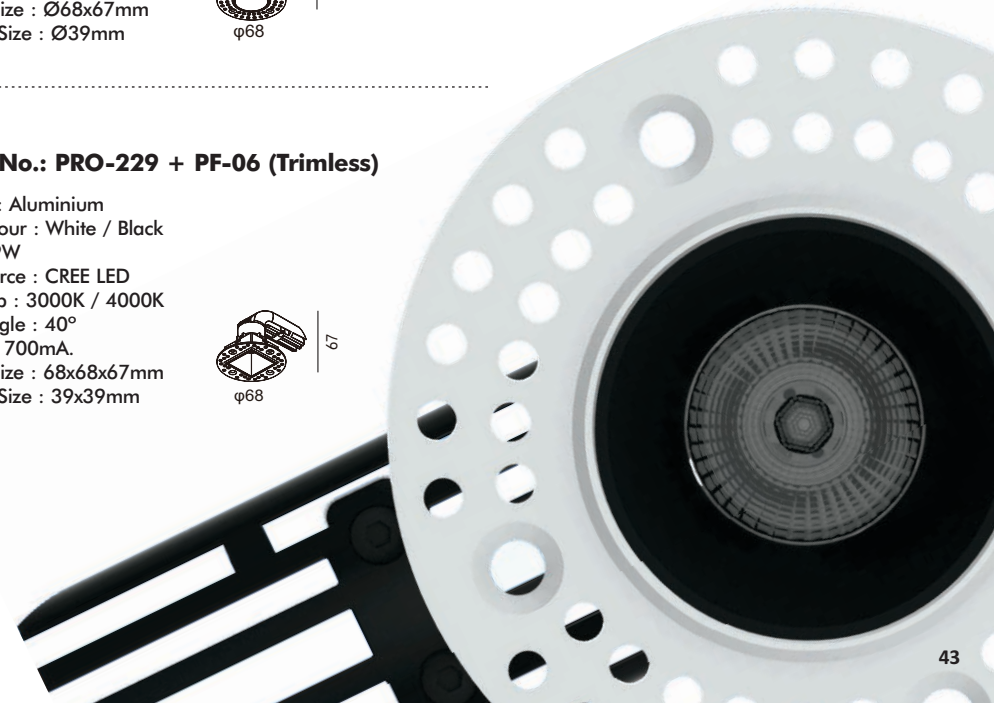
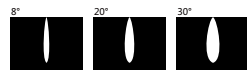

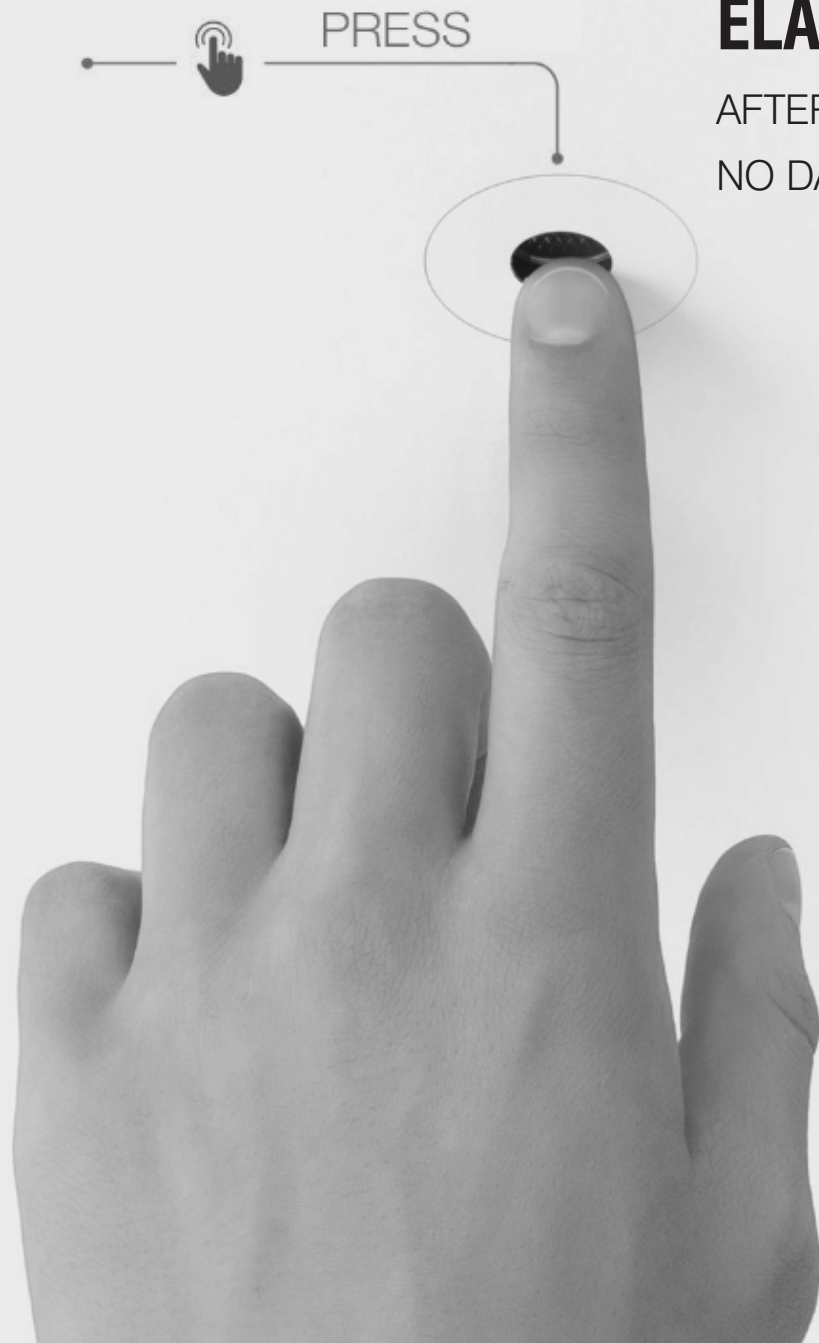

## ELABORATE MAINTENANCE.

AFTER INSTALLATION,  
NO DAMAGE TO FINAL FINISHING

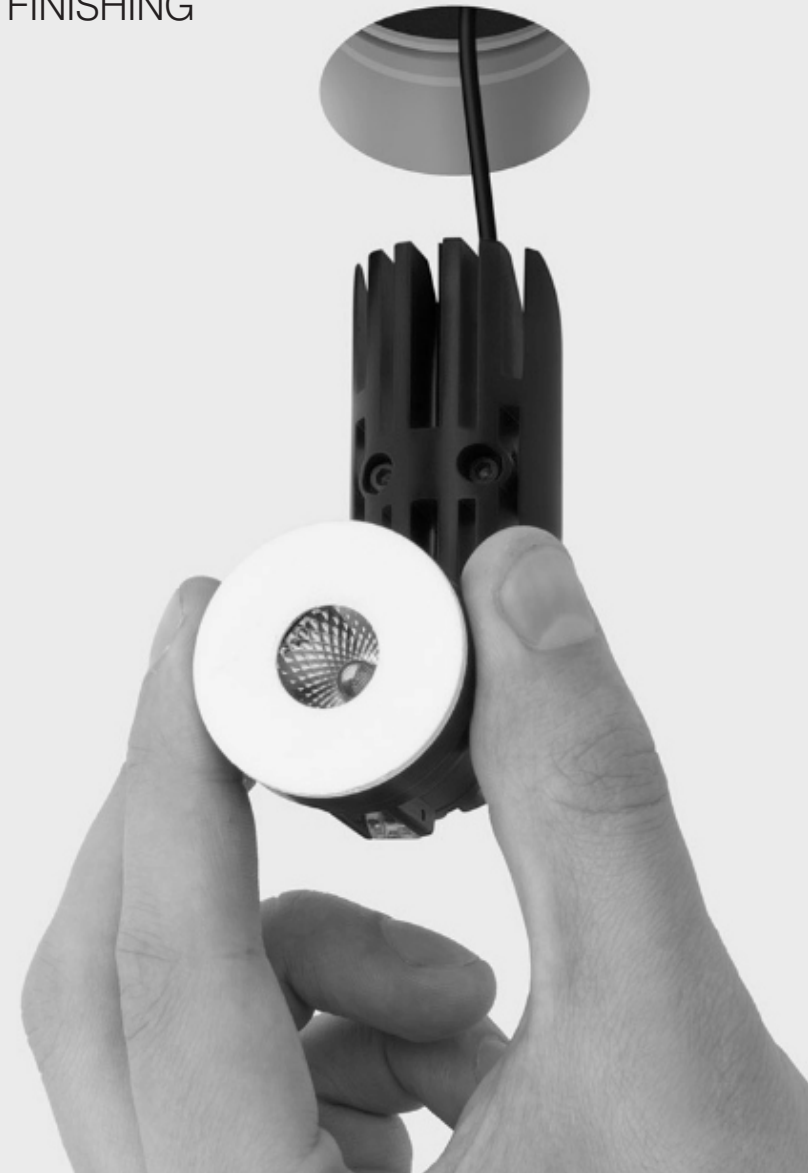

# 9W LOW HEIGHT LUMINAIRE

## DISTINCTIVE FEATURES

Minimalistic and modern design. Mounted flush with the ceiling.

Seamless transition between the luminaire and the ceiling due to concealed mounting technology.

Thus, the luminaire become an integral part of the interior. The series also features luminaires with a decorative trim.

## HEATSHINK

The unique design of the radiator is HYBEC PRO's most recent development (patented).

It provides effective heat dissipation, which is essential for high brightness luminaires,

and allows the height of the ceilings to remain intact due to small installation depth (67 mm).

### Model No.: PRO-224

Material : Aluminium

Body Colour : White / Black

Power : 9W

Light Source : CREE LED

Col. Temp : 3000K / 4000K

Beam Angle : 40°

Current : 700mA.

Product Size : Ø48x55mm

Cut-Out Size : Ø44mm

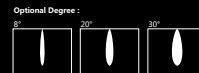

### Model No.: PRO-224 + PF-04 (Trimless)

Material : Aluminium

Body Colour : White / Black

Power : 9W

Light Source : CREE LED

Col. Temp : 3000K / 4000K

Beam Angle : 40°

Current : 700mA.

Product Size : 68x55mm

Cut-Out Size : Ø39mm





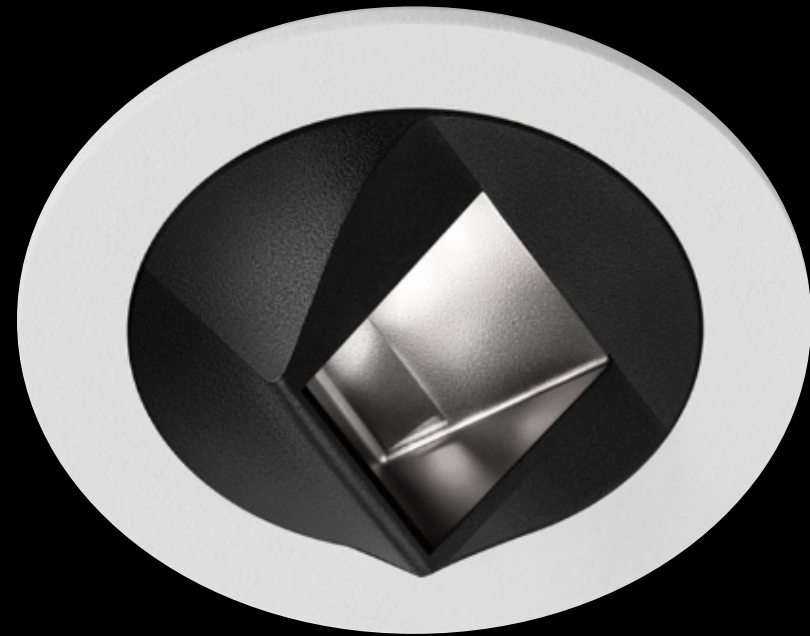
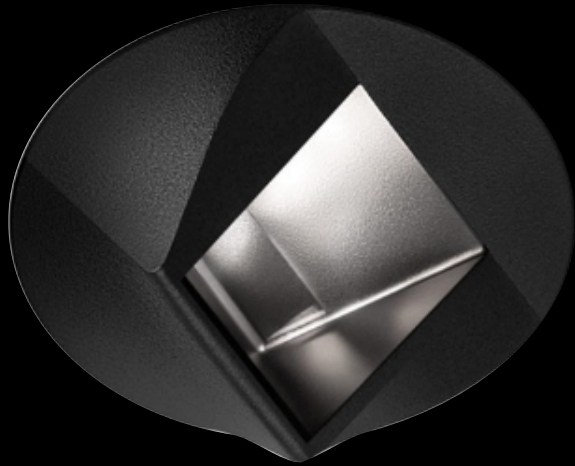

## **VECTOR LIGHT LENS**

DIRECTS LIGHT ON WALL UNDER  
60° ANGLE

# 9W LOW HEIGHT LUMINARE - WALL WASHERS

## Model No.: PRO-226



Material : Aluminium  
Body Colour : White / Black  
Power : 7W  
Light Source : CREE LED  
Col. Temp : 3000K / 4000K  
Beam Angle : 40°  
Current : 500mA.  
Product Size : Ø48x70mm  
Cut-Out Size : Ø44mm



## Model No.: PRO-226 + PF-04 (Trimless)

Material : Aluminium  
Body Colour : White / Black  
Power : 7W  
Light Source : CREE LED  
Col. Temp : 3000K / 4000K  
Beam Angle : 40°  
Current : 500mA.  
Product Size : Ø68x70mm  
Cut-Out Size : Ø39mm

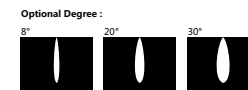

## Model No.: PRO-230



Material : Aluminium  
Body Colour : White / Black  
Power : 7W  
Light Source : CREE LED  
Col. Temp : 3000K / 4000K  
Beam Angle : 40°  
Current : 500mA.  
Product Size : 48x48x70mm  
Cut-Out Size : 44x44mm



## Model No.: PRO-230 + PF-06 (Trimless)

Material : Aluminium  
Body Colour : White / Black  
Power : 7W  
Light Source : CREE LED  
Col. Temp : 3000K / 4000K  
Beam Angle : 40°  
Current : 500mA.  
Product Size : Ø68x70mm  
Cut-Out Size : 39x39mm





# 9W LOW HEIGHT LUMINARE - EYEBALL



## Model No.: PRO-228

Material : Aluminium  
Body Colour : White / Black  
Power : 9W  
Light Source : CREE LED  
Col. Temp : 3000K / 4000K  
Beam Angle : 40°  
Current : 700mA.  
Product Size : Ø80x58mm  
Cut-Out Size : Ø56mm



## Model No.: PRO-228 + PF-08 (Trimless)

Material : Aluminium  
Body Colour : White / Black  
Power : 9W  
Light Source : CREE LED  
Col. Temp : 3000K / 4000K  
Beam Angle : 40°  
Current : 700mA.  
Product Size : Ø62x58mm  
Cut-Out Size : Ø54mm

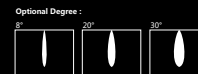



## GLARE-LESS DARK REFLECTOR SERIES

**- Cut-off angle is 40°. Suppresses discomfort glare in field of view.**

Designed with the cut-off angle of 40° to keep light out of the sight, considering human's line of vision and elevation angle.

It is a glare-less light, an "eye-friendly" light eliminating offensive glare.

**- Low luminance mirror-finish cone does not insist its presence.**

Fixture design suppressing the lighting feel, blending into the space.

Thanks to a light distribution design that minimizes the amount of light striking the cone combined with the mirror-finish cone, the fixture blends into the space instead of calling attention to itself.

Less reflected glare on windowpanes allow more beautiful night view.

**- Cone variation that allows the selection of lighting feel suitable the space.**

You can select the cone of the most appropriate luminance for the space situation or interior color, from the mirror-finish cone that suppresses glare or the black cone that hides the fixture presence.





# GLARE-LESS DARK REFLECTOR SERIES

## LED MODULE LIGHT Model No.: PRO-101

Housing Material : Aluminium  
Power : **6W**  
Light Source : BRIDGELUX LED  
Col. Temp.: 3000K / 4000K / 5000K  
Beam Angle : 38°  
CRI >80  
Current : DC 500mA

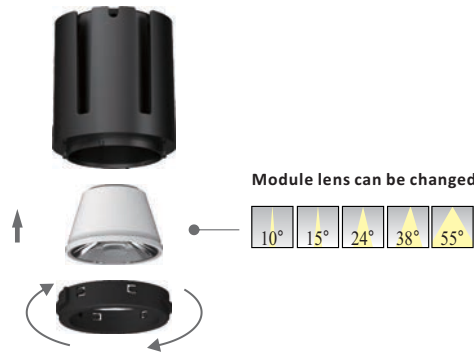
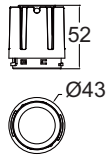

### OPTIONAL REFLECTORS



NEW

Model No.: P61 (Tiltable)  
Product Size : ø75x70mm  
Cut-Out Size : ø65mm  
**Optional Frame :**  
**Matt White / Matt Black**



NEW

Model No.: P62 (Tiltable)  
Product Size : 75x75x70mm  
Cut-Out Size : 65x65mm  
**Optional Frame :**  
**Matt White / Matt Black**



Model No.: P65 (Fixed)  
Product Size : ø62x85mm  
Cut-Out Size : ø55mm  
Body Colour : Matt White / Black  
Optional Reflectors : White /  
Matt Silver / Titanium Black



Model No.: P67 (Fixed Trimless)  
Product Size : ø85x55mm  
Cut-Out Size : ø55mm  
Body Colour : Matt White  
Optional Reflectors : White /  
Matt Silver / Titanium Black



NEW

Model No.: P63 (Tiltable)  
Product Size : 140x75x70mm  
Cut-Out Size : 130x65mm  
**Optional Frame :**  
**Matt White / Matt Black**



Model No.: P66 (Tiltable)  
Product Size : ø62x85mm  
Cut-Out Size : ø55mm  
Body Colour : Matt White / Black  
Optional Reflectors : White /  
Matt Silver / Chrome / Titanium Black



Model No.: P68 (Tiltable Trimless)  
Product Size : ø85x55mm  
Cut-Out Size : ø55mm  
Body Colour : Matt White  
Optional Reflectors : White /  
Matt Silver / Chrome / Titanium Black









# GLARE-LESS DARK REFLECTOR SERIES

## LED MODULE LIGHT Model No.: PRO-102

Housing Material : Aluminium  
 Power : **9W**  
 Light Source : BRIDGELUX LED  
 Col. Temp. : 3000K / 4000K / 5000K  
 Beam Angle : 38°  
 CRI > 80  
 Current : DC 200mA

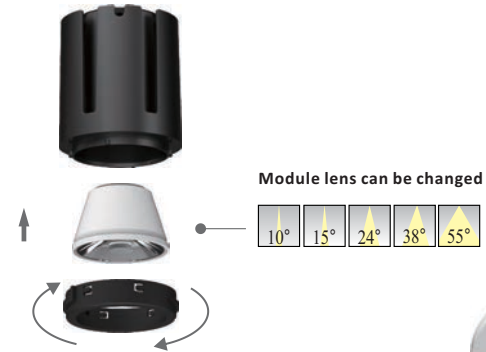
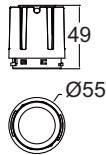

Model No.: P71 (Fixed)  
 Product Size : ø68x64mm  
 Cut-Out Size : ø60mm  
 Optional Reflectors :  
 Matt Silver / Titanium Black



Model No.: P73 (Fixed)  
 Product Size : ø85x89mm  
 Cut-Out Size : ø75mm  
 Optional Reflectors : White /  
 Matt Silver / Chrome / Titanium Black



Model No.: P75 (Tiltable)  
 Product Size : ø96x68mm  
 Cut-Out Size : ø85mm  
**Optional Frame :**  
**Matt White / Matt Black**



Model No.: P76 (Fixed Trimless)  
 Product Size : ø71x89mm  
 Cut-Out Size : ø76mm  
 Optional Reflectors : White /  
 Matt Silver / Chrome / Titanium Black



Model No.: P79 (Fixed)  
 Product Size : ø85x107mm  
 Cut-Out Size : ø75mm  
 Reflectors : White / Matt Silver



Model No.: P72 (Fixed)  
 Product Size : ø85x67mm  
 Cut-Out Size : ø75mm  
 Optional Reflectors :  
 Matt Silver / Titanium Black



Model No.: P74 (Tiltable)  
 Product Size : ø85x89mm  
 Cut-Out Size : ø75mm  
 Optional Reflectors : White /  
 Matt Silver / Chrome / Titanium Black



Model No.: P77 (Tiltable Trimless)  
 Product Size : ø71x89mm  
 Cut-Out Size : ø76mm  
 Optional Reflectors : White /  
 Matt Silver / Chrome / Titanium Black



Model No.: P80 (Fixed)  
 Product Size : 85x85x107mm  
 Cut-Out Size : 75x75mm  
 Reflectors : White / Matt Silver



**- Cut-off angle is 40°. Suppresses discomfort glare in field of view.**

Designed with the cut-off angle of 40° to keep light out of the sight, considering human's line of vision and elevation angle. It is a glare-less light, an "eye-friendly" light eliminating offensive glare.

**- Low luminance mirror-finish cone does not insist its presence.**

Fixture design suppressing the lighting feel, blending into the space. Thanks to a light distribution design that minimizes the amount of light striking the cone combined with the mirror-finish cone, the fixture blends into the space instead of calling attention to itself. Less reflected glare on windowpanes allow more beautiful night view.

**- Cone variation that allows the selection of lighting feel suitable the space.**

You can select the cone of the most appropriate luminance for the space situation or interior color, from the mirror-finish cone that suppresses glare or the black cone that hides the fixture presence.



Model No.: P85 (Fixed)  
Product Size : ø102x95mm  
Cut-Out Size : ø90mm  
Optional Reflectors : White /  
Matt Silver / Chrome / Titanium Black



Model No.: P87 (Fixed Trimless)  
Product Size : ø85x95mm  
Cut-Out Size : ø90mm  
Optional Reflectors : White /  
Matt Silver / Chrome / Titanium Black



Model No.: P81 (Tiltable)  
Product Size : 85x85x89mm  
Cut-Out Size : 75x75mm  
Optional Reflectors :  
Matt Silver / Titanium Black



Model No.: P82 (Fixed)  
Product Size : 155x85x89mm  
Cut-Out Size : 140x75mm  
**Optional Frame : White / Black**  
**Reflectors : Titanium Black**



Model No.: P84 (Tiltable)  
Product Size : 90x90x71mm  
Cut-Out Size : 80x80mm  
**Optional Frame :  
Matt White / Matt Black**



Model No.: P86 (Tiltable)  
Product Size : ø102x95mm  
Cut-Out Size : ø90mm  
Optional Reflectors : White /  
Matt Silver / Chrome / Titanium Black



Model No.: P88 (Tiltable Trimless)  
Product Size : ø85x95mm  
Cut-Out Size : ø90mm  
Optional Reflectors : White /  
Matt Silver / Chrome / Titanium Black



Model No.: P82-AJ (Tiltable)  
Product Size : 155x85x89mm  
Cut-Out Size : 140x75mm  
**Optional Frame : White / Black**  
**Reflectors : Titanium Black**



Model No.: P83 (Tiltable)  
Product Size : ø90x71mm  
Cut-Out Size : 80mm  
**Optional Frame :  
Matt White / Matt Black**



Model No.: P89 (Tiltable)  
Product Size : 175x90x71mm  
Cut-Out Size : 165x80mm  
**Optional Frame :  
Matt White / Matt Black**





# GLARE-LESS DARK REFLECTOR SERIES

## LED MODULE LIGHT Model No.: PRO-104

Housing Material : Aluminium  
Power : **15W**  
Light Source : BRIDGELUX LED  
Col. Temp.: 3000K / 4000K / 5000K  
Beam Angle : 38°  
CRI >80  
Current : DC 350mA

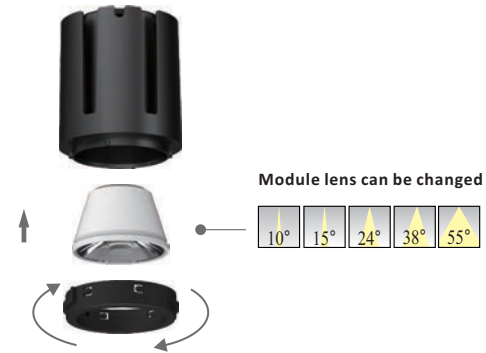
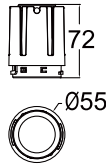

Model No.: P71 (Fixed)  
Product Size : ø68x87mm  
Cut-Out Size : ø60mm  
Optional Reflectors :  
Matt Silver / Titanium Black



Model No.: P73 (Fixed)  
Product Size : ø85x112mm  
Cut-Out Size : ø75mm  
Optional Reflectors : White /  
Matt Silver / Chrome / Titanium Black



Model No.: P75 (Tiltable)  
Product Size : ø96x91mm  
Cut-Out Size : ø85mm  
**Optional Frame :**  
**Matt White / Matt Black**



Model No.: P76 (Fixed Trimless)  
Product Size : ø71x112mm  
Cut-Out Size : ø76mm  
Optional Reflectors : White /  
Matt Silver / Chrome / Titanium Black



Model No.: P79 (Fixed)  
Product Size : ø85x130mm  
Cut-Out Size : ø75mm  
Reflectors : White / Matt Silver



Model No.: P72 (Fixed)  
Product Size : ø85x90mm  
Cut-Out Size : ø75mm  
Optional Reflectors :  
Matt Silver / Titanium Black



Model No.: P74 (Tiltable)  
Product Size : ø85x112mm  
Cut-Out Size : ø75mm  
Optional Reflectors : White /  
Matt Silver / Chrome / Titanium Black



Model No.: P77 (Tiltable Trimless)  
Product Size : ø71x112mm  
Cut-Out Size : ø76mm  
Optional Reflectors : White /  
Matt Silver / Chrome / Titanium Black



Model No.: P80 (Fixed)  
Product Size : 85x85x130mm  
Cut-Out Size : 75x75mm  
Reflectors : White / Matt Silver

**- Cut-off angle is 40°. Suppresses discomfort glare in field of view.**

Designed with the cut-off angle of 40° to keep light out of the sight, considering human's line of vision and elevation angle. It is a glare-less light, an "eye-friendly" light eliminating offensive glare.

**- Low luminance mirror-finish cone does not insist its presence.**

Fixture design suppressing the lighting feel, blending into the space. Thanks to a light distribution design that minimizes the amount of light striking the cone combined with the mirror-finish cone, the fixture blends into the space instead of calling attention to itself. Less reflected glare on windowpanes allow more beautiful night view.

**- Cone variation that allows the selection of lighting feel suitable the space.**

You can select the cone of the most appropriate luminance for the space situation or interior color, from the mirror-finish cone that suppresses glare or the black cone that hides the fixture presence.

**OPTIONAL REFLECTORS**



**ACCESSORIES**

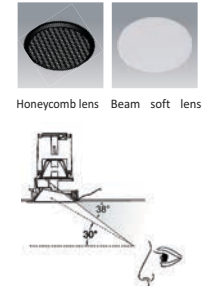

Model No.: P85 (Fixed)  
Product Size : ø102x118mm  
Cut-Out Size : ø90mm  
Optional Reflectors : White /  
Matt Silver / Chrome / Titanium Black



Model No.: P87 (Fixed Trimless)  
Product Size : ø85x118mm  
Cut-Out Size : ø90mm  
Optional Reflectors : White /  
Matt Silver / Chrome / Titanium Black



Model No.: P81 (Tiltable)  
Product Size : 85x85x112mm  
Cut-Out Size : 75x75mm  
Optional Reflectors :  
Matt Silver / Titanium Black



Model No.: P82 (Fixed)  
Product Size : 155x85x112mm  
Cut-Out Size : 140x75mm  
**Optional Frame : White / Black**  
**Reflectors : Titanium Black**



Model No.: P84 (Tiltable)  
Product Size : 90x90x94mm  
Cut-Out Size : 80x80mm  
**Optional Frame :**  
**Matt White / Matt Black**



Model No.: P86 (Tiltable)  
Product Size : ø102x118mm  
Cut-Out Size : ø90mm  
Optional Reflectors : White /  
Matt Silver / Chrome / Titanium Black



Model No.: P88 (Tiltable Trimless)  
Product Size : ø85x118mm  
Cut-Out Size : ø90mm  
Optional Reflectors : White /  
Matt Silver / Chrome / Titanium Black



Model No.: P82-AJ (Tiltable)  
Product Size : 155x85x112mm  
Cut-Out Size : 140x75mm  
**Optional Frame : White / Black**  
**Reflectors : Titanium Black**



Model No.: P83 (Tiltable)  
Product Size : ø90x94mm  
Cut-Out Size : 80mm  
**Optional Frame :**  
**Matt White / Matt Black**



Model No.: P89 (Tiltable)  
Product Size : 175x90x94mm  
Cut-Out Size : 165x80mm  
**Optional Frame :**  
**Matt White / Matt Black**



# GLARE-LESS DARK REFLECTOR SERIES

## LED MODULE LIGHT Model No.: PRO-106

Housing Material : Aluminium  
Power : **24W**  
Light Source : BRIDGELUX LED  
Col. Temp.: 3000K / 4000K / 5000K  
Beam Angle : 38°  
CRI > 80  
Current : DC 600mA

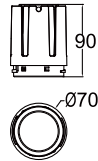

### OPTIONAL REFLECTORS



### ACCESSORIES



Model No.: P90 (Fixed)  
Product Size : ø112x140mm  
Cut-Out Size : ø100mm  
Optional Reflectors : White /  
Matt Silver / Chrome / Titanium Black



Model No.: P94 (Fixed Trimless)  
Product Size : ø95x140mm  
Cut-Out Size : ø100mm  
Optional Reflectors : White /  
Matt Silver / Chrome / Titanium Black



NEW

Model No.: P92 (Tiltable)  
Product Size : ø110x116mm  
Cut-Out Size : ø95mm  
**Optional Reflectors :**  
**Matt White / Matt Black**



Model No.: P96 (Fixed)  
Product Size : ø112x165mm  
Cut-Out Size : ø100mm  
Optional Reflectors : Matt Silver



Model No.: P91 (Tiltable)  
Product Size : ø112x140mm  
Cut-Out Size : ø100mm  
Optional Reflectors : White /  
Matt Silver / Chrome / Titanium Black



Model No.: P95 (Tiltable Trimless)  
Product Size : ø95x140mm  
Cut-Out Size : ø100mm  
Optional Reflectors : White /  
Matt Silver / Chrome / Titanium Black



Model No.: P97 (Fixed)  
Product Size : 112x112x168mm  
Cut-Out Size : 100x100mm  
Optional Reflectors : Matt Silver

# GLARE-LESS DARK REFLECTOR SERIES



## LED MODULE LIGHT Model No.: PRO-107

Housing Material : Aluminium  
 Power : **33W**  
 Light Source : BRIDGELUX LED  
 Col. Temp.: 3000K / 4000K / 5000K  
 Beam Angle : 38°  
 CRI > 80  
 Current : DC 600mA

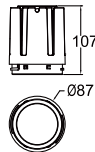

## LED MODULE LIGHT Model No.: PRO-108

Housing Material : Aluminium  
 Power : **42W**  
 Light Source : BRIDGELUX LED  
 Col. Temp.: 3000K / 4000K / 5000K  
 Beam Angle : 38°  
 CRI > 80  
 Current : DC 600mA

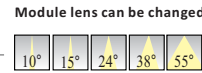
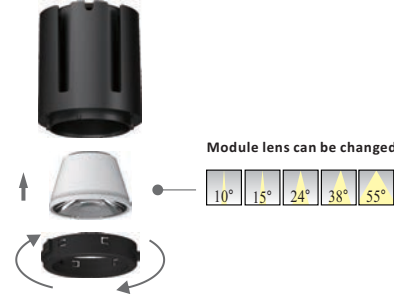
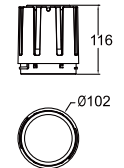

Model No.: P98 (Fixed)  
 Product Size : ø140x169mm  
 Cut-Out Size : ø125mm  
 Optional Reflectors :  
 Matt Silver / Titanium Black



Model No.: P93 (Tilttable)  
 Product Size : ø130x139mm  
 Cut-Out Size : ø115mm  
**Optional Reflectors :**  
**Matt White / Matt Black**



Model No.: P100 (Fixed)  
 Product Size : ø165x184mm  
 Cut-Out Size : ø150mm  
 Optional Reflectors :  
 Matt Silver / Titanium Black



Model No.: P99 (Tilttable)  
 Product Size : ø140x169mm  
 Cut-Out Size : ø125mm  
 Optional Reflectors :  
 Matt Silver / Titanium Black



Model No.: P101 (Tilttable)  
 Product Size : ø165x184mm  
 Cut-Out Size : ø150mm  
 Optional Reflectors :  
 Matt Silver / Titanium Black



## SLIMMEST RIM DEEP RECESSED SERIES

---

**SOLUTION WITH,**

**4W  
8W  
13W & 20W**

With a family of 4W, 8W, 13W & 20W, available with different rings as per your choice and design. from, SLIMRIM TO TRIMLESS, from down light to wall washers.



## SLIMMEST RIM DEEP RECESSED SERIES

### LED MODULE LIGHT Model No.: PRO-121

Housing Material : Aluminium  
Power : **4W**  
Light Source : CREE LED  
Col. Temp.: 3000K / 4000K / 6000K  
Beam Angle : 24°  
CRI >80  
Current : DC 350mA

OPTIONAL DEGREES ON REQUEST

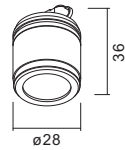
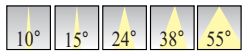

Model No.: R1  
Body Colour : White Outer Rim with Black  
Product Size :  $\phi 45 \times 56 \text{mm}$   
Cut-Out Size :  $\phi 37 \text{mm}$



Model No.: R2  
Body Colour : White  
Product Size :  $\phi 45 \times 54 \text{mm}$   
Cut-Out Size :  $\phi 40 \text{mm}$



Model No.: R3  
Body Colour : Gold  
Product Size :  $\phi 45 \times 54 \text{mm}$   
Cut-Out Size :  $\phi 40 \text{mm}$



# SLIMMEST RIM DEEP RECESSED SERIES

## LED MODULE LIGHT Model No.: PRO-123

Housing Material : Aluminium  
 Power : **8W**  
 Light Source : CREE LED  
 Col. Temp.: 3000K / 4000K / 6000K  
 Beam Angle : 30°  
 CRI >80  
 Current : DC 350mA

OPTIONAL DEGREES ON REQUEST

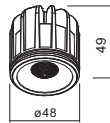
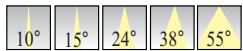

Model No.: R11  
 Body Colour : White Outer Rim with Black  
 Product Size : ø65x70mm  
 Cut-Out Size : ø58mm



Model No.: R12  
 Body Colour : White / Black  
 Product Size : ø82x88mm  
 Cut-Out Size : ø77mm



Model No.: R13  
 Body Colour : Gold  
 Product Size : ø82x88mm  
 Cut-Out Size : ø77mm



Model No.: R14  
 Body Colour : White with White Frame  
 Product Size : 80x80x86mm  
 Cut-Out Size : 68x68mm



Model No.: R15  
 Body Colour : Gold with White Frame  
 Product Size : 80x80x86mm  
 Cut-Out Size : 68x68mm



# SLIMMEST RIM DEEP RECESSED SERIES

## LED MODULE LIGHT Model No.: PRO-124

Housing Material : Aluminium  
 Power : **13W**  
 Light Source : CREE LED  
 Col. Temp.: 3000K / 4000K  
 Beam Angle : 30°  
 CRI >80  
 Current : DC 350mA

OPTIONAL DEGREES ON REQUEST

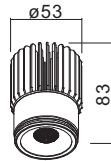

Model No.: R11  
 Body Colour : White Outer Rim with Black  
 Product Size :  $\phi 65 \times 95 \text{mm}$   
 Cut-Out Size :  $\phi 58 \text{mm}$



Model No.: R12  
 Body Colour : White / Black  
 Product Size :  $\phi 82 \times 124 \text{mm}$   
 Cut-Out Size :  $\phi 77 \text{mm}$



Model No.: R13  
 Body Colour : Gold  
 Product Size :  $\phi 82 \times 124 \text{mm}$   
 Cut-Out Size :  $\phi 77 \text{mm}$



Model No.: R14  
 Body Colour : White with White Frame  
 Product Size :  $82 \times 82 \times 124 \text{mm}$   
 Cut-Out Size :  $77 \times 77 \text{mm}$



Model No.: R15  
 Body Colour : Gold with White Frame  
 Product Size :  $82 \times 82 \times 124 \text{mm}$   
 Cut-Out Size :  $77 \times 77 \text{mm}$



# SLIMMEST RIM DEEP RECESSED SERIES

## LED MODULE LIGHT Model No.: PRO-125

Housing Material : Aluminium  
 Power : **20W**  
 Light Source : CREE LED  
 Col. Temp.: 3000K / 4000K  
 Beam Angle : 30°  
 CRI >80  
 Current : DC 500mA

OPTIONAL DEGREES ON REQUEST

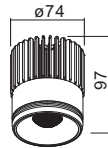
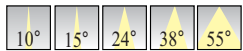

Model No.: R21  
 Body Colour : White Outer Rim with Black  
 Product Size :  $\phi 91 \times 141$ mm  
 Cut-Out Size :  $\phi 82$ mm



Model No.: R22  
 Body Colour : White  
 Product Size :  $\phi 106 \times 159$ mm  
 Cut-Out Size :  $\phi 100$ mm



Model No.: R23  
 Body Colour : Gold  
 Product Size :  $\phi 106 \times 159$ mm  
 Cut-Out Size :  $\phi 100$ mm



**HYBEC® PRO**  
 lighting the future







2 / 26



6°

**SLIMMEST RIM DEEP RECESSED SPOT**

**LED MODULE LIGHT**  
Model No.: PRO-122

Housing Material : Aluminium Die-Cast  
Power : **7W**  
Light Source : CREE LED  
Col. Temp.: 3000K / 4000K  
Beam Angle : 6°  
CRI > 80  
Current : DC 500mA/12V



Model No.: R11  
Body Colour : White Outer Rim with Black  
Product Size : ø65x70mm  
Cut-Out Size : ø58mm



Model No.: R12  
Body Colour : White / Black  
Product Size : ø82x88mm  
Cut-Out Size : ø77mm



Model No.: R13  
Body Colour : Gold  
Product Size : ø82x88mm  
Cut-Out Size : ø77mm





Model No.: R14  
Body Colour : White with White Frame  
Product Size : 80x80x86mm  
Cut-Out Size : 68x68mm



Model No.: R15  
Body Colour : Gold with White Frame  
Product Size : 80x80x86mm  
Cut-Out Size : 68x68mm

213

TUMI

ANNA  
SUI  
for  
TUMI

Anna Sui's designs are a mix of vintage and modern, and her collections are always full of personality. She is a true fashionista, and her designs are always full of personality. She is a true fashionista, and her designs are always full of personality.

EVERY  
SUI  
for  
TUMI





## TRIMELESS EYEBALL SPOT LIGHT SERIES

FAMILY OF  
**4W**  
**8W**  
**13W & 20W**

Specially designed Lens system make a great contribution to the uniformity, which offer high visual comfort. Die casting aluminium with excellent thermal management, provide 3-year guarantee.

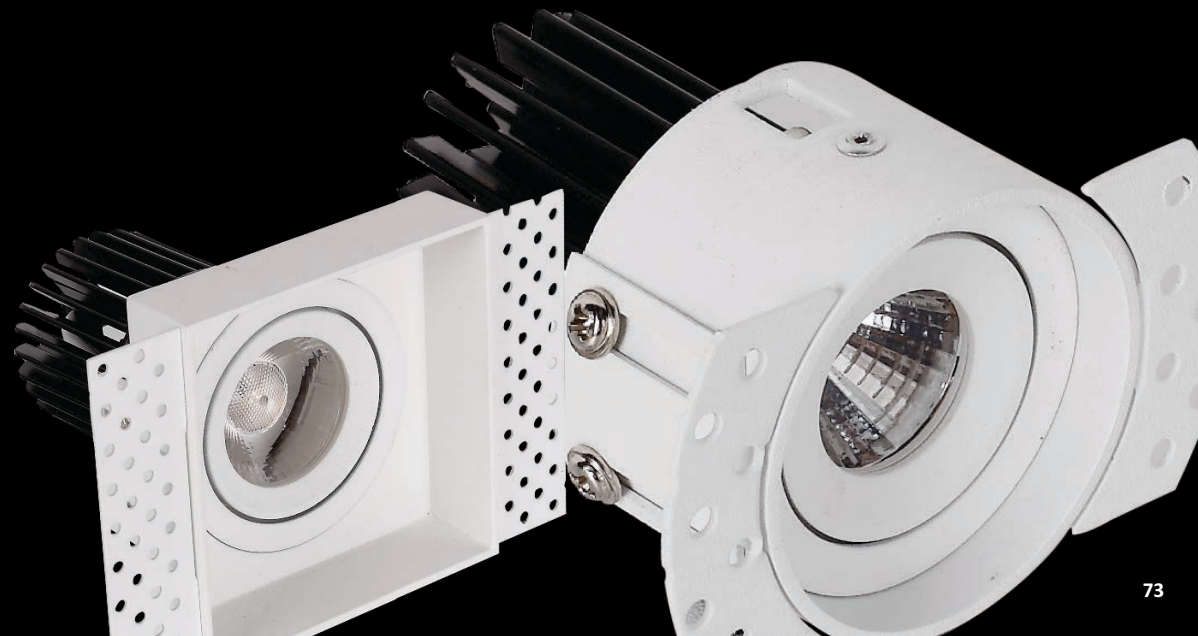
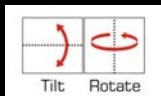
Difference size with different wattage, trim and trimless frame, different color options gives a designer flexibility combination. Installation without tools using snap spring closure; protection class IP20.



# TRIMLESS EYEBALL SPOT LIGHT SERIES

## LED MODULE LIGHT Model No.: PRO-121



Housing Material : Aluminium  
Power : **4W**  
Light Source : CREE LED  
Col. Temp.: 3000K / 4000K  
Beam Angle : 24°  
CRI >80  
Current : DC 350mA

OPTIONAL DEGREES ON REQUEST

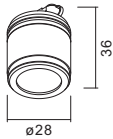
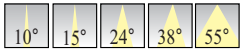

Model No.: R5 (Trimless)  
Body Colour : White / Black  
Product Size : 73x49mm  
Cut-Out Size : 58mm



Model No.: R6 (Trimless)  
Body Colour : White / Black  
Product Size : 83x83x49mm  
Cut-Out Size : 57x57mm

## LED MODULE LIGHT Model No.: PRO-123



Housing Material : Aluminium  
Power : **8W**  
Light Source : CREE LED  
Col. Temp.: 3000K / 4000K / 6000K  
Beam Angle : 30°  
CRI >80  
Current : DC 350mA

OPTIONAL DEGREES ON REQUEST

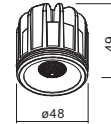

Model No.: R26 (Trimless)  
Body Colour : White / Black  
Product Size : 111x69mm  
Cut-Out Size : 83mm



Model No.: R28 (Trimless)  
Body Colour : White / Black  
Product Size : 185x142x75mm  
Cut-Out Size : 186x95mm



Model No.: R27 (Trimless)  
Body Colour : White / Black  
Product Size : 142x92x73mm  
Cut-Out Size : 94x94mm

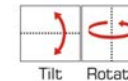

# TRIMLESS EYEBALL SPOT LIGHT SERIES

## LED MODULE LIGHT Model No.: PRO-124



Housing Material : Aluminium  
Power : **13W**  
Light Source : CREE LED  
Col. Temp.: 3000K / 4000K  
Beam Angle : 30°  
CRI >80  
Current : DC 350mA

OPTIONAL DEGREES ON REQUEST

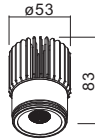
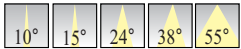

Model No.: R26 (Trimless)  
Body Colour : White / Black  
Product Size :  $\phi$ 111x103mm  
Cut-Out Size :  $\phi$ 83mm



Model No.: R27 (Trimless)  
Body Colour : White / Black  
Product Size : 142x92x107mm  
Cut-Out Size : 94x94mm



Model No.: R28 (Trimless)  
Body Colour : White / Black  
Product Size : 185x142x109mm  
Cut-Out Size : 186x95mm

## LED MODULE LIGHT Model No.: PRO-125



Housing Material : Aluminium  
Power : **20W**  
Light Source : CREE LED  
Col. Temp.: 3000K / 4000K  
Beam Angle : 30°  
CRI >80  
Current : DC 500mA

OPTIONAL DEGREES ON REQUEST

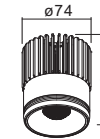
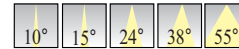

Model No.: R24 (Trimless)  
Body Colour : White  
Product Size :  $\phi$ 175x129mm  
Cut-Out Size :  $\phi$ 118mm

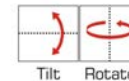





# DIY WITH TRIMLESS SPOT LIGHT SERIES

---

Assemble flexibly according to your like. All of shapes can be created on the ceiling, also suitable for replacement projects. Shielding angle over 30 degree and special construction design offer a fabulous eye-comfort. Rotatable can be 355 degree.

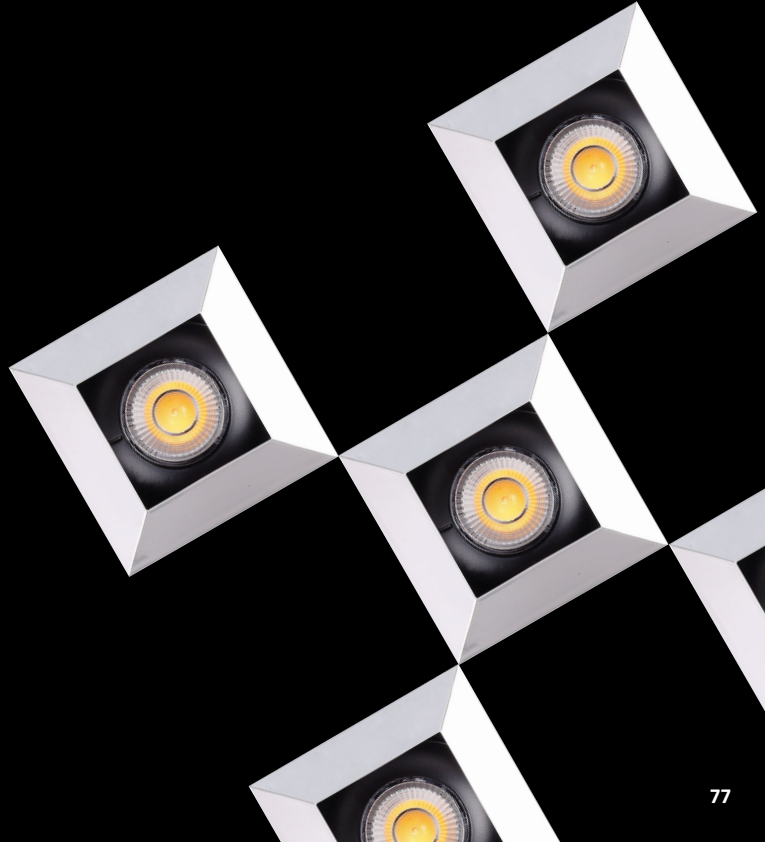



# DIY TRIMLESS SPOT LIGHT SERIES

## LED MODULE LIGHT

Model No.: PRO-123

Housing Material : Aluminium  
 Power : **8W**  
 Light Source : CREE LED  
 Col. Temp.: 3000K / 4000K / 6000K  
 Beam Angle : 30°  
 CRI > 80  
 Current : DC 350mA



OPTIONAL DEGREES ON REQUEST

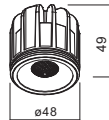
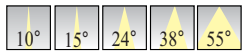

Model No.: R29 (Trimless)  
 Body Colour : Black  
 Product Size : 148x148x92mm  
 Cut-Out Size : 105x105mm  
 Optional Frame : White / Black

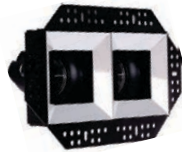

Model No.: R30 (Trimless)  
 Body Colour : Black  
 Product Size : 243x148x92mm  
 Cut-Out Size : 200x105mm  
 Optional Frame : White / Black



Model No.: R31 (Trimless)  
 Body Colour : Black  
 Product Size : 338x148x92mm  
 Cut-Out Size : 295x105mm  
 Optional Frame : White / Black



Model No.: R32 (Trimless)  
 Body Colour : Black  
 Product Size : 243x243x92mm  
 Cut-Out Size : 200x200mm  
 Optional Frame : White / Black



Model No.: R33 (Trimless)  
 Body Colour : Black  
 Product Size : 338x338x92mm  
 Cut-Out Size : 295x295mm  
 Optional Frame : White / Black



**B26:**  
 Inside Frame : White / Black



**LED MODULE LIGHT**  
**Model No.: PRO-124**

Housing Material : Aluminium  
Power : **13W**  
Light Source : CREE LED  
Col. Temp.: 3000K / 4000K  
Beam Angle : 30°  
CRI >80  
Current : DC 350mA

OPTIONAL DEGREES ON REQUEST

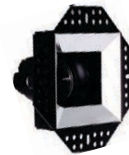
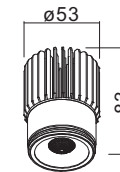
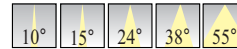

Model No.: R29 (Trimless)  
Body Colour : Black  
Product Size : 148x148x125mm  
Cut-Out Size : 105x105mm  
Optional Frame : White / Black

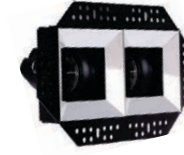

Model No.: R30 (Trimless)  
Body Colour : Black  
Product Size : 243x148x125mm  
Cut-Out Size : 200x105mm  
Optional Frame : White / Black



Model No.: R31 (Trimless)  
Body Colour : Black  
Product Size : 338x148x125mm  
Cut-Out Size : 295x105mm  
Optional Frame : White / Black



Model No.: R32 (Trimless)  
Body Colour : Black  
Product Size : 243x243x125mm  
Cut-Out Size : 200x200mm  
Optional Frame : White / Black



Model No.: R33 (Trimless)  
Body Colour : Black  
Product Size : 338x338x125mm  
Cut-Out Size : 295x295mm  
Optional Frame : White / Black



**B26:**  
**Inside Frame : White / Black**



## DEEP RECESSED EYEBALL / WALL WASHER SERIES

---

Specially designed Lens system make a great contribution to the uniformity, which offer high visual comfort. Die casting aluminium with excellent thermal management, provide 3-year guarantee.

Difference size with different wattage, trim and trimless frame, different color options gives a designer flexibility combination. Installation without tools using snap spring closure; protection class IP20.



## DEEP RECESSED EYE-BALL SERIES (ROUND)

### LED MODULE LIGHT

Model No.: PRO-123



Housing Material : Aluminium  
 Power : **8W**  
 Light Source : CREE LED  
 Col. Temp.: 3000K / 4000K / 6000K  
 Beam Angle : 30°  
 CRI > 80  
 Current : DC 350mA

OPTIONAL DEGREES ON REQUEST

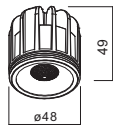
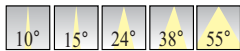

### LED MODULE LIGHT

Model No.: PRO-124



Housing Material : Aluminium  
 Power : **13W**  
 Light Source : CREE LED  
 Col. Temp.: 3000K / 4000K  
 Beam Angle : 30°  
 CRI > 80  
 Current : DC 350mA

OPTIONAL DEGREES ON REQUEST

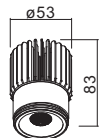

Model No.: R35  
 Body Colour : White  
 Product Size : ø85x104mm  
 Cut-Out Size : ø75mm



Model No.: R36  
 Body Colour : Black  
 Product Size : ø85x104mm  
 Cut-Out Size : ø75mm



Model No.: R37  
 Body Colour : Gold  
 Product Size : ø85x104mm  
 Cut-Out Size : ø75mm



Model No.: R35  
 Body Colour : White  
 Product Size : ø85x124mm  
 Cut-Out Size : ø75mm



Model No.: R36  
 Body Colour : Black  
 Product Size : ø85x124mm  
 Cut-Out Size : ø75mm



Model No.: R37  
 Body Colour : Gold  
 Product Size : ø85x124mm  
 Cut-Out Size : ø75mm



**HYBEC<sup>®</sup> PRO**  
lighting the future



## DEEP RECESSED WALL WASHER SERIES (ROUND)

### LED MODULE LIGHT

Model No.: PRO-123



Housing Material : Aluminium  
 Power : **8W**  
 Light Source : CREE LED  
 Col. Temp.: 3000K / 4000K / 6000K  
 Beam Angle : 30°  
 CRI > 80  
 Current : DC 350mA

OPTIONAL DEGREES ON REQUEST

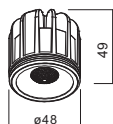
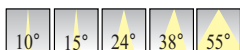

Model No.: R38 (Wall Washer)  
 Body Colour : White  
 Product Size : ø100x104mm  
 Cut-Out Size : ø90mm



Model No.: R39 (Wall Washer)  
 Body Colour : Black  
 Product Size : ø100x104mm  
 Cut-Out Size : ø90mm



Model No.: R40 (Wall Washer)  
 Body Colour : Gold  
 Product Size : ø100x104mm  
 Cut-Out Size : ø90mm

### LED MODULE LIGHT

Model No.: PRO-124



Housing Material : Aluminium  
 Power : **13W**  
 Light Source : CREE LED  
 Col. Temp.: 3000K / 4000K  
 Beam Angle : 30°  
 CRI > 80  
 Current : DC 350mA

OPTIONAL DEGREES ON REQUEST

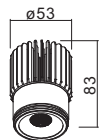

Model No.: R38 (Wall Washer)  
 Body Colour : White  
 Product Size : ø100x121mm  
 Cut-Out Size : ø90mm



Model No.: R39 (Wall Washer)  
 Body Colour : Black  
 Product Size : ø100x121mm  
 Cut-Out Size : ø90mm



Model No.: R40 (Wall Washer)  
 Body Colour : Gold  
 Product Size : ø100x121mm  
 Cut-Out Size : ø90mm





## DEEP RECESSED EYE-BALL SERIES (SQUARE)

### LED MODULE LIGHT

Model No.: PRO-123

Housing Material : Aluminium  
 Power : **8W**  
 Light Source : CREE LED  
 Col. Temp.: 3000K / 4000K / 6000K  
 Beam Angle : 30°  
 CRI > 80  
 Current : DC 350mA



OPTIONAL DEGREES ON REQUEST

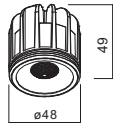
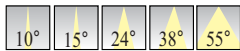

### LED MODULE LIGHT

Model No.: PRO-124

Housing Material : Aluminium  
 Power : **13W**  
 Light Source : CREE LED  
 Col. Temp.: 3000K / 4000K  
 Beam Angle : 30°  
 CRI > 80  
 Current : DC 350mA



OPTIONAL DEGREES ON REQUEST

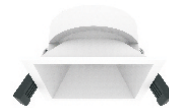
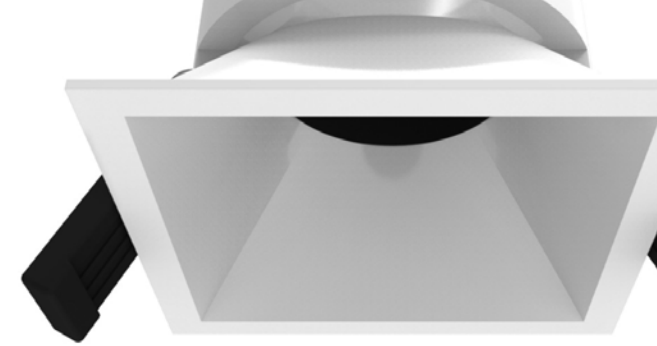
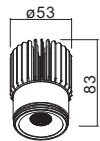

Model No.: R43  
 Body Colour : White  
 Product Size : 85x85x104mm  
 Cut-Out Size : 75x75mm



Model No.: R44  
 Body Colour : Black  
 Product Size : 85x85x104mm  
 Cut-Out Size : 75x75mm



Model No.: R45  
 Body Colour : Gold  
 Product Size : 85x85x104mm  
 Cut-Out Size : 75x75mm

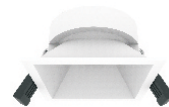

Model No.: R43  
 Body Colour : White  
 Product Size : 85x85x124mm  
 Cut-Out Size : 75x75mm



Model No.: R44  
 Body Colour : Black  
 Product Size : 85x85x124mm  
 Cut-Out Size : 75x75mm



Model No.: R45  
 Body Colour : Gold  
 Product Size : 85x85x124mm  
 Cut-Out Size : 75x75mm

# DEEP RECESSED WALL WASHER SERIES (SQUARE)

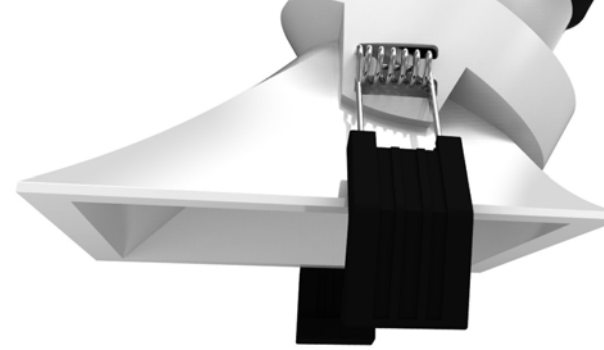

## LED MODULE LIGHT Model No.: PRO-123



Housing Material : Aluminium  
Power : **8W**  
Light Source : CREE LED  
Col. Temp.: 3000K / 4000K / 6000K  
Beam Angle : 30°  
CRI > 80  
Current : DC 350mA

OPTIONAL DEGREES ON REQUEST

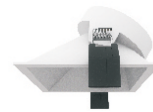
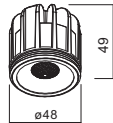

Model No.: R47 (Wall Washer)  
Body Colour : White  
Product Size : 100x100x104mm  
Cut-Out Size : 90x90mm



Model No.: R48 (Wall Washer)  
Body Colour : Black  
Product Size : 100x100x104mm  
Cut-Out Size : 90x90mm



Model No.: R49 (Wall Washer)  
Body Colour : Gold  
Product Size : 100x100x104mm  
Cut-Out Size : 90x90mm

## LED MODULE LIGHT Model No.: PRO-124



Housing Material : Aluminium  
Power : **13W**  
Light Source : CREE LED  
Col. Temp.: 3000K / 4000K  
Beam Angle : 30°  
CRI > 80  
Current : DC 350mA

OPTIONAL DEGREES ON REQUEST

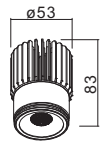

Model No.: R47 (Wall Washer)  
Body Colour : White  
Product Size : 100x100x121mm  
Cut-Out Size : 90x90mm



Model No.: R48 (Wall Washer)  
Body Colour : Black  
Product Size : 100x100x121mm  
Cut-Out Size : 90x90mm



Model No.: R49 (Wall Washer)  
Body Colour : Gold  
Product Size : 100x100x121mm  
Cut-Out Size : 90x90mm



## CHROME REFLECTOR WALL WASHER SERIES (ROUND / SQUARE)

Specially designed Lens system make a great contribution to the uniformity, which offer high visual comfort. Die casting aluminium with excellent thermal management, provide 3-year guarantee.

Difference size with different wattage, trim and trimless frame, different color options gives a designer flexibility combination. Installation without tools using snap spring closure; protection class IP20.

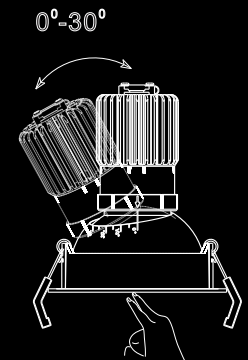
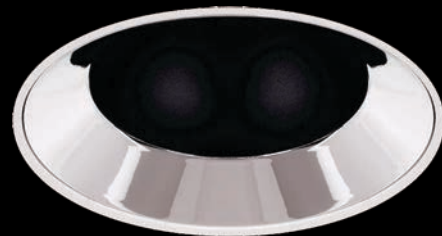

**LED MODULE LIGHT**  
**Model No.: PRO-124**

Housing Material : Aluminium  
 Power : **13W**  
 Light Source : CREE LED  
 Col. Temp.: 3000K / 4000K  
 Beam Angle : 30°  
 CRI > 80  
 Current : DC 350mA

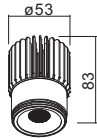

Model No.: R16  
 Body Colour : Chrome with White Frame  
 Product Size :  $\phi$ 115x135mm  
 Cut-Out Size :  $\phi$ 100mm



Model No.: R16 (Trimless)  
 Body Colour : Chrome with White Frame  
 Product Size :  $\phi$ 150x135mm  
 Cut-Out Size :  $\phi$ 100mm



Model No.: R18  
 Body Colour : Chrome with White Frame  
 Product Size : 115x115x139mm  
 Cut-Out Size : 102x102mm



Model No.: R18 (Trimless)  
 Body Colour : Chrome with White Frame  
 Product Size : 159x115x139mm  
 Cut-Out Size : 104x97mm



*Hard Rock*  
HOTEL

MACAU

## CHROME FINISH SPOT LIGHT

Specially designed Lens system make a great contribution to the uniformity, which offer high visual comfort. Die casting aluminium with excellent thermal management, provide 3-year guarantee.

Difference size with different wattage, trim and trimless frame, different color options gives a designer flexibility combination. Installation without tools using snap spring closure; protection class IP20.



### Model No.: PRO-126

Housing Material : Aluminium Die-Casting  
Body Colour : **Chrome**  
Power : **13W**  
Light Source : CREE LED  
Led Color : 3000K / 4000K  
Beam Angle : 75.4°  
CRI : >80  
Current : 6V 350mA





# NARROW DEGREE SPOT LIGHT.



Specially designed Lens system make a great contribution to the uniformity, which offer high visual comfort. Die casting aluminium with excellent thermal management, provide 3-year guarantee.

Difference size with different wattage, trim and trimless frame, different color options gives a designer flexibility combination. Installation without tools using snap spring closure; protection class IP20.



## Model No.: PRO-129 (Trimless)

Housing Material : Aluminium Die-Cast  
 Body Colour : **Black**  
 Power : **8W**  
 Light Source : CREE LED  
 LED Colors : 3000K / 4000K  
 Beam Angle : 15°  
 CRI : 90  
 Current : 500mA - 12V  
 OD : Ø100x54mm  
 CD : Ø50mm

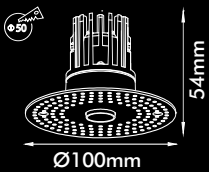

## Model No.: PRO-130

Housing Material : Aluminium Die-Cast  
 Body Colour : **White / Matte Black**  
 Power : **9W**  
 Light Source : CREE LED  
 LED Colors : 3000K / 4000K  
 Beam Angle : 16.8°  
 CRI : 90  
 Current : 500mA  
 OD : Ø60x54mm  
 CD : Ø50mm

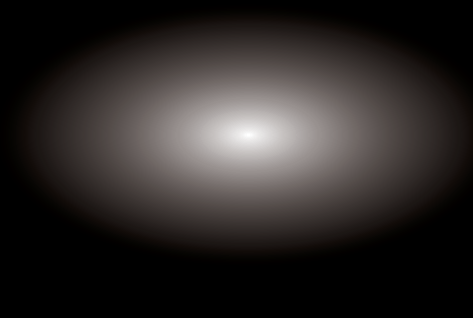
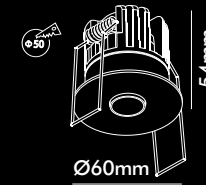



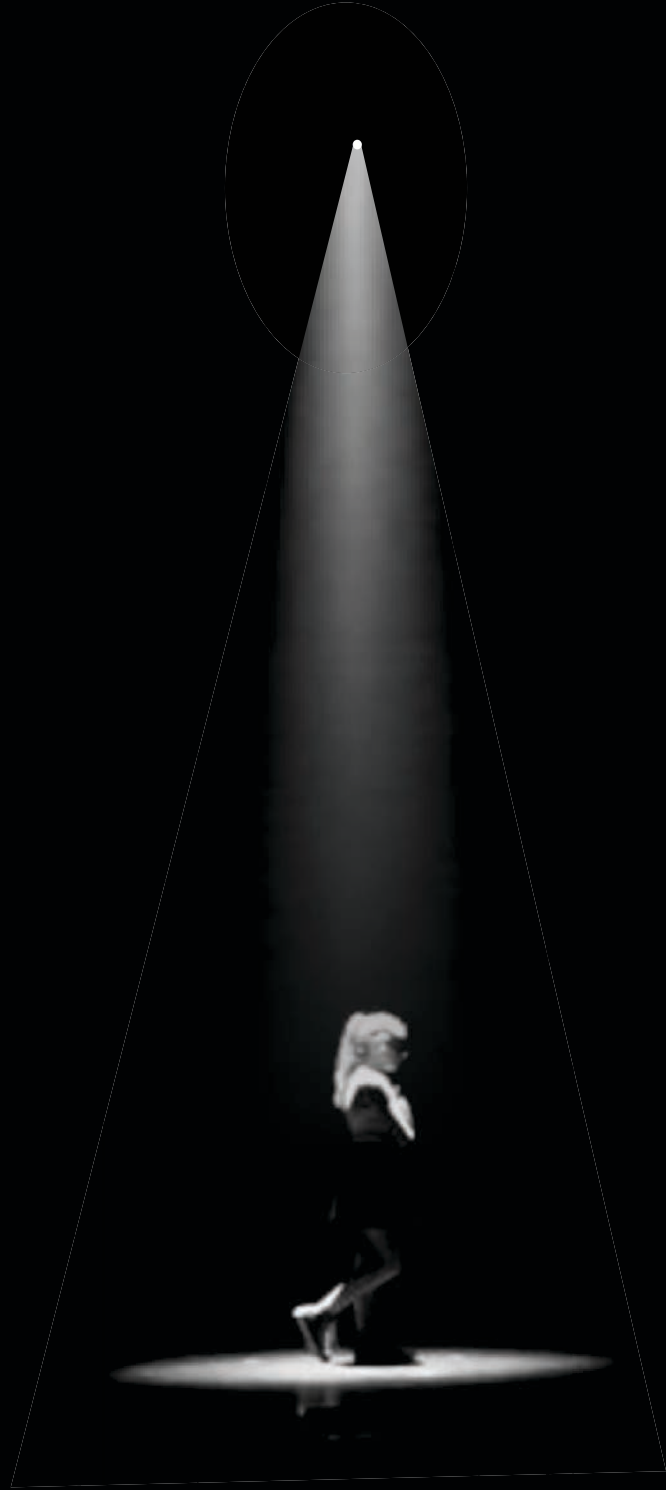

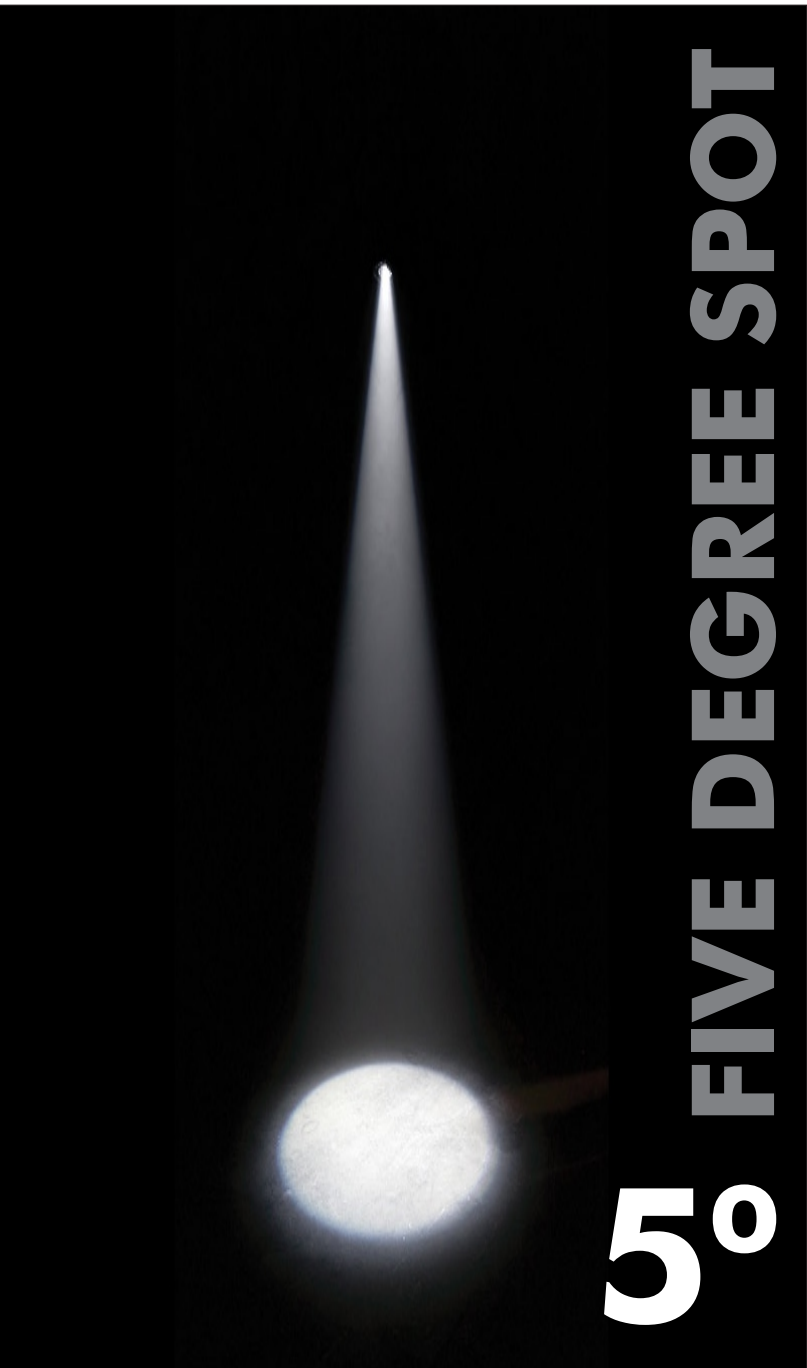

5°

DEEP RECESSED SPOT LIGHT SERIES



**Model No.: PRO-131**

Housing Material : Aluminium Die-Cast  
 Body Colour : White / Black  
 Power : 7W  
 Light Source : CREE LED  
 Col. Temp : 3000K / 4000K  
 Beam Angle : 5°  
 CRI : 90  
 Current : 500mA - 12V  
 OD : Ø56x70mm  
 CD : Ø50mm  
 IP : IP32

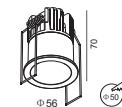

**Model No.: PRO-132**

Housing Material : Aluminium Die-Cast  
 Body Colour : White / Black  
 Power : 7W  
 Light Source : CREE LED  
 Col. Temp : 3000K / 4000K  
 Beam Angle : 5°  
 CRI : 90  
 Current : 500mA - 12V  
 OD : 56x56x74mm  
 CD : 50x50mm  
 IP : IP32

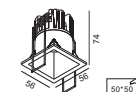



# DEEP RECESSED SPOT LIGHT SERIES



**Model No.: PRO-135**

Housing Material : Aluminium Die-Cast  
Body Colour : White / Black  
Power : 9W  
Light Source : BRIDGELUX LED  
Col. Temp : 3000K / 4000K  
Beam Angle : 24°  
CRI : 90  
Current : 200mA  
OD : 56x56x68mm  
CD : 46x46mm



**Model No.: PRO-141**

Housing Material : Aluminium Die-Cast  
Body Colour : White / Black  
Power : 9W  
Light Source : BRIDGELUX LED  
Col. Temp : 3000K / 4000K  
Beam Angle : 24°  
CRI : 90  
Current : 200mA  
OD : Ø56x68mm  
CD : Ø48mm



**Model No.: PRO-151**

Housing Material : Aluminium Die-Cast  
Body Colour : White  
Power : 9W  
Light Source : BRIDGELUX LED  
Col. Temp : 3000K / 4000K  
Beam Angle : 36°  
CRI : 90  
Current : 200mA  
OD : Ø60x85mm  
CD : Ø55mm



**Model No.: PRO-142**

Housing Material : Aluminium Die-Cast  
Body Colour : White  
Power : 7W / 10W / 15W  
Light Source : BRIDGELUX LED  
Col. Temp : 3000K / 4000K  
Beam Angle : 36°  
CRI : 90  
Current : 200mA/300mA/350mA  
OD : Ø82x75mm  
CD : Ø75mm



**Model No.: PRO-143A**

Housing Material : Aluminium Die-Cast  
Body Colour : White  
Power : 30W  
Light Source : BRIDGELUX LED  
Col. Temp : 3000K / 4000K  
Beam Angle : 36°  
CRI : 90  
Current : 800mA  
OD : Ø125x128mm  
CD : Ø120mm



**Model No.: PRO-143**

Housing Material : Aluminium Die-Cast  
Body Colour : White  
Power : 38W  
Light Source : LUMINUS LED  
Col. Temp : 3000K / 4000K  
Beam Angle : 38°  
CRI : 90  
Current : 1000mA  
OD : Ø125x128mm  
CD : Ø120mm

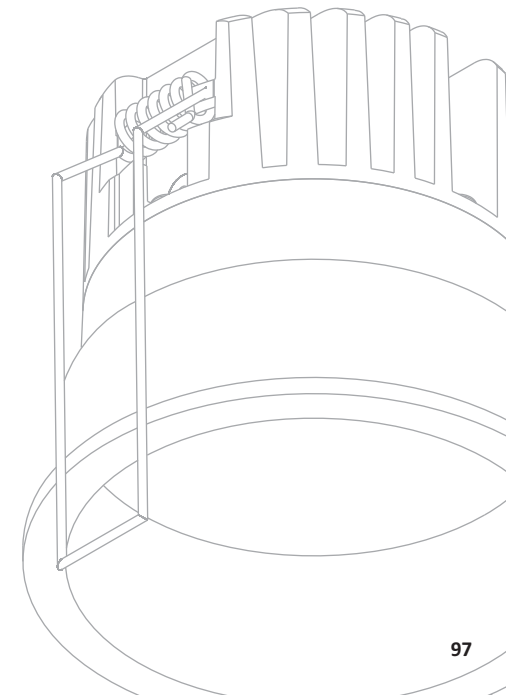

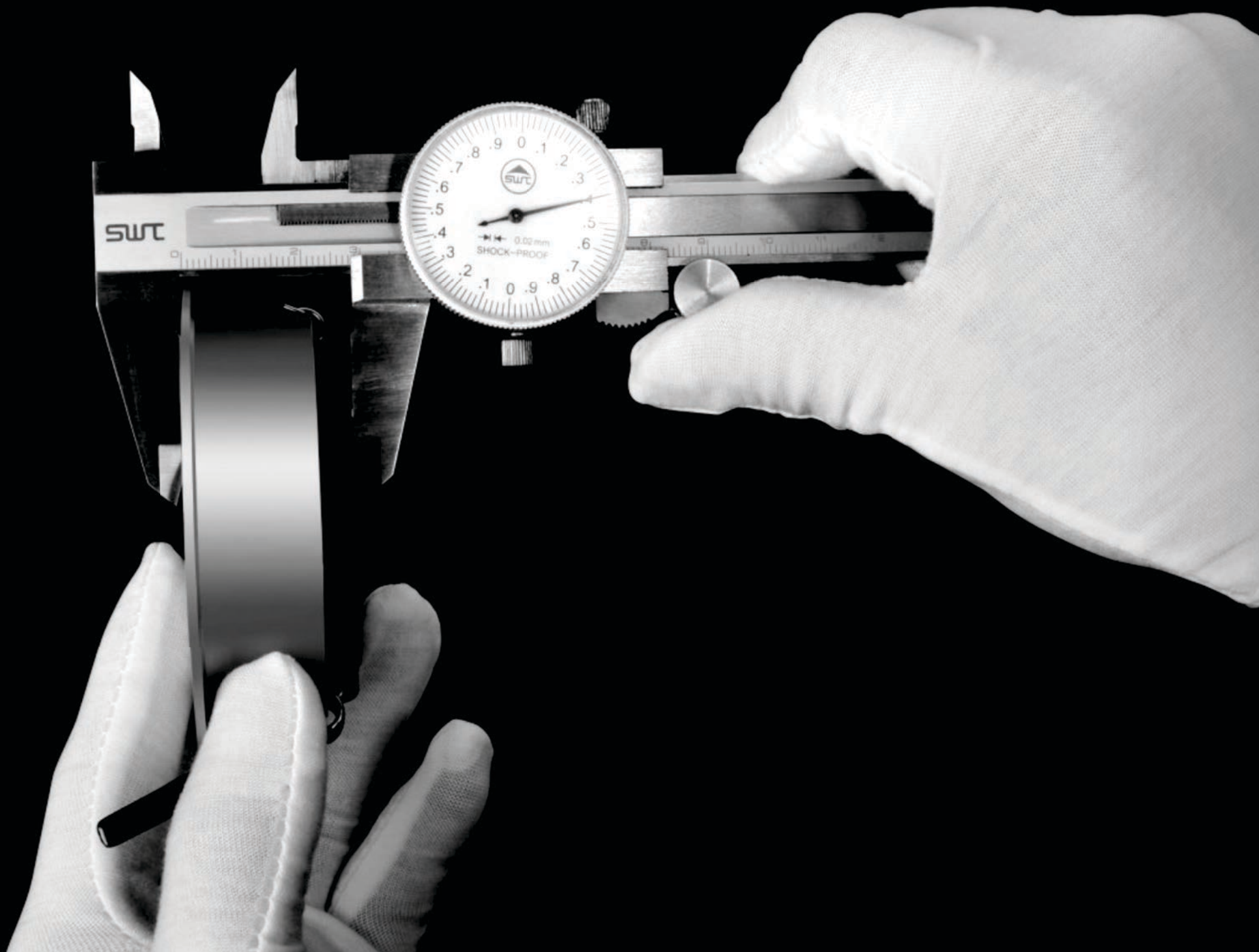

## 35MM LOW HEIGHT SPOT LIGHT - IP54

Low Height Spot Light, Adjustable, IP54 Grade.



### Model No.: PRO-155

Housing Material : Aluminium Die-Cast  
Body Colour : White  
Power : 9.3W / 13.8W  
Light Source : BRIDGELUX LED  
Col. Temp.: 3000K / 4000K  
Beam Angle : 38°  
CRI : 90  
Current : 350mA/500mA

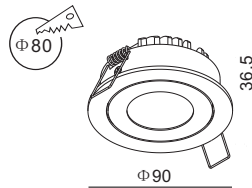



## SQUARE SHAPE WALL WASHER LIGHT

The Light is designed to be hidden in the box. Tilttable upto 30°.



### Model No.: PRO-156

Housing Material : Aluminium Die-Cast  
Body Colour : White  
Power : 14W  
Light Source : Bridgelux LED  
Col.Temp.: 3000K / 4000K  
Beam Angle : 30°  
CRI : 90  
Current : 450mA

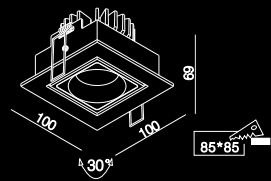

## TRIMLESS DEEP RECESSED SPOT LIGHT

A trimless design which makes itself perfectly blended with ceiling after installation, and creates an illusion that only light comes out from the ceiling but no site of lamps when it is on.

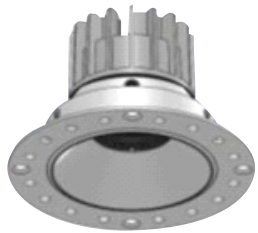

### Model No.: PRO-160 (TRIMLESS)

Housing Material : Aluminium Die-Cast

Body Colour : White

Power : 6.2W

Light Source : Bridgelux LED

Col. Temp.: 3000K / 4000K

Beam Angle : 23°

CRI : 90

Current : 350mA

Input : 220-240VAC, 50/60Hz

Size : Ø110x75mm

Cutout : Ø80mm

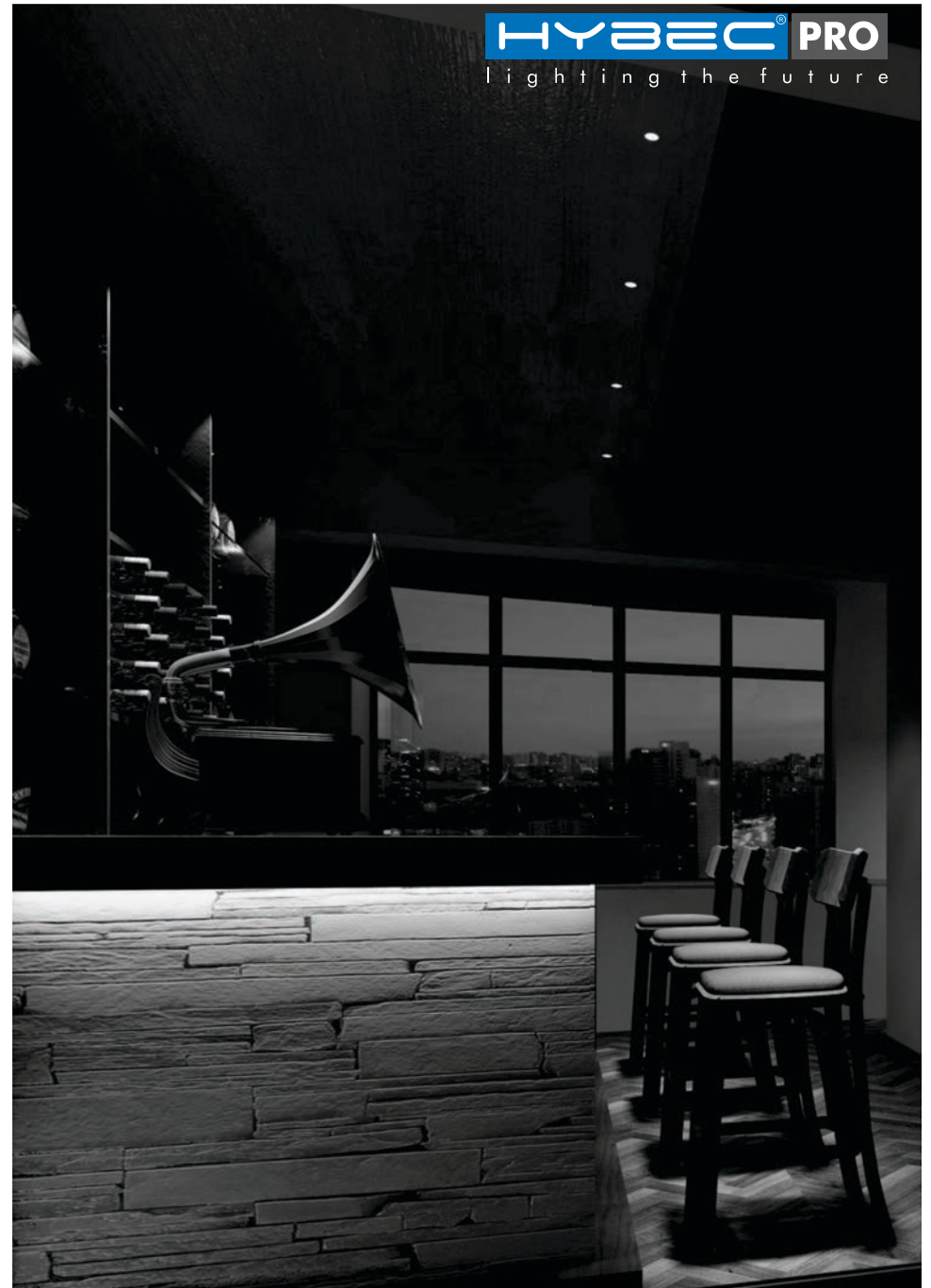
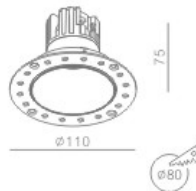





## TRIMLESS DEEP RECESSED SPOT LIGHT SERIES (ROUND)

A trimless design which makes itself perfectly blended with ceiling after installation, and creates an illusion that only light comes out from the ceiling but no site of lamps when it is on.

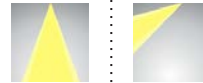

### Model No.: PRO-161

Housing Material : Aluminium Die-Cast  
Body Colour : White  
Power : 13W  
Light Source : Luminus LED  
Col. Temp.: 3000K / 4000K  
Beam Angle : 38°  
CRI : 95  
Current : 350mA/36V DC  
Cut-Out : Ø110mm

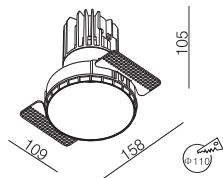

Also available in Gold Finish



### Model No.: PRO-162

Housing Material : Aluminium Die-Cast  
Body Colour : White  
Power : 13W  
Light Source : Luminus LED  
Col. Temp.: 3000K / 4000K  
Beam Angle : 38°  
CRI : 95  
Current : 350mA/36V DC  
Cut-Out : Ø110mm

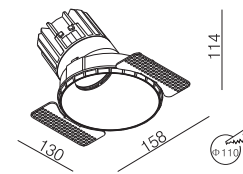

Also available in Gold Finish



## TRIMLESS DEEP RECESSED SPOT LIGHT SERIES (SQUARE)

A trimless design which makes itself perfectly blended with ceiling after installation, and creates an illusion that only light comes out from the ceiling but no site of lamps when it is on.

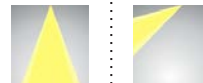

### Model No.: PRO-164

Housing Material : Aluminium Die-Cast  
Body Colour : White  
Power : 13W  
Light Source : Luminus LED  
Col. Temp.: 3000K / 4000K  
Beam Angle : 38°  
CRI : 95  
Current : 350mA/36V DC  
Cut-Out : 110mm x 100mm

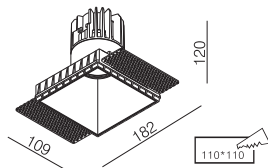

Also available in Gold Finish



### Model No.: PRO-165

Housing Material : Aluminium Die-Cast  
Body Colour : White  
Power : 13W  
Light Source : Luminus LED  
Col. Temp.: 3000K / 4000K  
Beam Angle : 38°  
CRI : 95  
Current : 350mA/36V DC  
Cut-Out : 110mm x 100mm

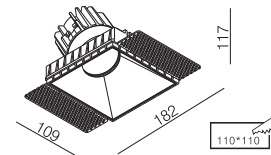

Also available in Gold Finish



## DEEP RECESSED SPOT LIGHT SERIES (ROUND / SQUARE)

The series is using a light source hidden deeply, thus anti-glare effect is rather good, users can adjust the angle of illumination. Equipped with 3 spare lenses : the honeycomb cover, wave glass and ruled glass, user select the suitable one according to their application.



### Model No.: PRO-171

Housing Material : Aluminium Die-Cast  
Body Colour : White with Black deep  
Power : 13W  
Light Source : Luminus LED  
Col. Temp : 3000K / 4000K  
Beam Angle : 24°  
CRI : 95  
Current : 350mA  
OD : Ø115x108mm  
CD : Ø100mm



### Model No.: PRO-172

Housing Material : Aluminium Die-Cast  
Body Colour : White with Gold deep  
Power : 13W  
Light Source : Luminus LED  
Col. Temp : 3000K / 4000K  
Beam Angle : 24°  
CRI : 95  
Current : 350mA  
OD : Ø115x108mm  
CD : Ø100mm



### Model No.: PRO-174

Housing Material : Aluminium Die-Cast  
Body Colour : White with Black deep  
Power : 13W  
Light Source : Luminus LED  
Col. Temp : 3000K / 4000K  
Beam Angle : 24°  
CRI : 95  
Current : 350mA  
OD : 115x115x108mm  
CD : 100x100mm

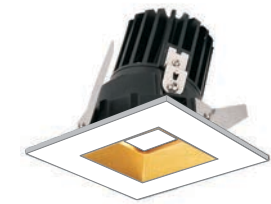

### Model No.: PRO-175

Housing Material : Aluminium Die-Cast  
Body Colour : White with Gold deep  
Power : 13W  
Light Source : Luminus LED  
Col. Temp : 3000K / 4000K  
Beam Angle : 24°  
CRI : 95  
Current : 350mA  
OD : 115x115x108mm  
CD : 100x100mm



HONEYCOMB COVER  
Model : S-10



GRAINED COVER  
Model : S-11



RULED COVER  
Model : S-12

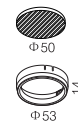
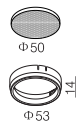
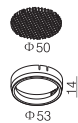





## SQUARE SHAPE SPOT LIGHT

Simple design and compact size makes the square shape spot light look compact on ceiling. Deeply installed light source gives soft and harmonious light with best anti-glare effect.

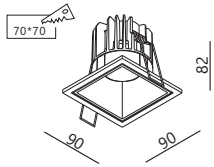

### Model No.: PRO-181

Housing Material : Aluminium Die-Cast  
Body Colour : White  
Power : 15W  
Light Source : BRIDGELUX LED  
Col. Temp : 3000K / 4000K  
Beam Angle : 32°  
CRI : 80  
Current : 700mA

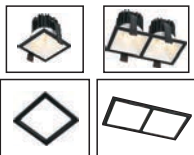

F1

F2







## CYLINDRICAL DEEP RECESSED SPOT LIGHT SERIES

The series is using a light source hidden deeply, thus anti-glare effect is rather good, users can adjust the angle of illumination. Complete range of products, offering a variety of installation, different power wattages and appearance options.



### Model No.: PRO-183

Housing Material : Aluminium Die-Cast  
Body Colour : White  
Power : 12W  
Light Source : Luminus LED  
Col. Temp : 3000K / 4000K  
Beam Angle : 28°  
CRI : 90  
Current : 250mA - 36V

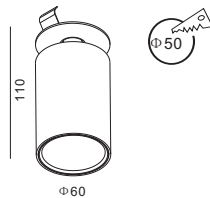

### Model No.: PRO-185

Housing Material : Aluminium Die-Cast  
Body Colour : White  
Power : 12W  
Light Source : Luminus LED  
Col. Temp : 3000K / 4000K  
Beam Angle : 28°  
CRI : 90  
Current : 250mA - 36V

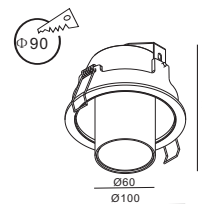

### Model No.: PRO-186

Housing Material : Aluminium Die-Cast  
Body Colour : White with Black ring  
Power : 11W  
Light Source : Bridgelux LED  
Col. Temp : 3000K / 4000K  
Beam Angle : 32°  
CRI : 90  
Current : 450mA

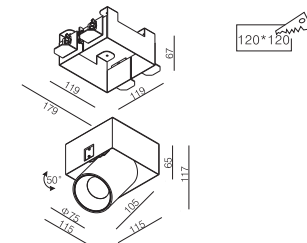



## SPHERE SHAPED DOWNLIGHT

This accurate sphere shaped downlight with marvelous antiglare function is the best choice for both residential and commercial spaces. The structure makes it possible to rotate the lamp upto 350 degree around.



### Model No.: PRO-187

Housing Material : Aluminium Die-Cast  
Body Colour : Matt White  
Power : 13W  
Light Source : CREE LED  
LED Colors : 4000K  
Beam Angle : 24°  
CRI : 80  
Current : 300mA



  $\phi$  84(Cut out)





## ASYMMETRIC WALL WASHER LIGHT

The series with 180 degree lense allow the light to fall evenly on the wall without making any scallop on the wall.  
Available in 9W and 17W also in Trimless series.

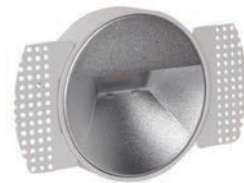

### Model No.: PRO-190 (TRIMLESS)

Housing Material : Aluminium Die-Cast  
Body Colour : White  
Power : 9W  
Light Source : CREE LED  
Col. Temp : 3000K / 4000K  
Beam Angle : 46x85°  
CRI : 80  
Current : 300mA

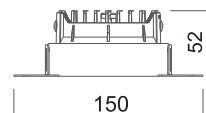

∅ 100(Cut out)



### Model No.: PRO-191

Housing Material : Aluminium Die-Cast  
Body Colour : White  
Power : 9W  
Light Source : CREE LED  
Col. Temp : 3000K / 4000K  
Beam Angle : 46x85°  
CRI : 80  
Current : 300mA

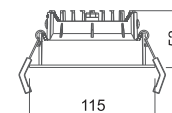

∅ 100(Cut out)



### Model No.: PRO-192

Housing Material : Aluminium Die-Cast  
Body Colour : White with Black ring  
Power : 17W  
Light Source : CREE LED  
Col. Temp : 3000K / 4000K  
Beam Angle : 46x85°  
CRI : 90  
Current : 350mA

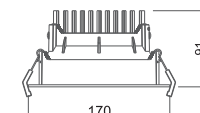

∅ 150(Cut out)

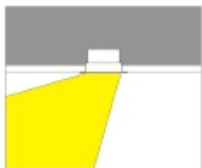



## 52W DOWNLIGHT

52W Downlight is good very a double height ceiling. Mostly suitable for Commercial Complex, Shopping Malls etc.



### Model No.: PRO-194

Housing Material : Aluminium Die-Cast  
Body Colour : White  
Power : 52W  
Light Source : BRIDGELUX LED  
Col. Temp : 3000K / 4000K  
Beam Angle : 72°  
CRI : 80  
Current : 1400mA (Meanwell)

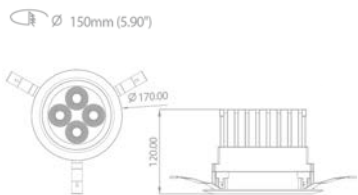





## ADJUSTABLE STIC SPOT LIGHT

---

Constructing geometric sculptures of light, STIC establishes an intimate relationship with space and combines functionality with beauty of pure lines. Narrow beam angle just 15D, it can create perfect light effect, focusing on separate objects in the room.

Installed in a group, with different heights and angles, STIC creates unique lighting pattern on the ceiling.



**Model No.: PRO-196**

Housing Material : Aluminium Die-Cast  
 Body Colour : White / Black  
 Power : 9W  
 Light Source : CREE LED  
 Col. Temp : 3000K / 4000K  
 Beam Angle : 15°  
 CRI : 80  
 Rotates : 355°  
 Size : Ø92mm x H250mm  
 Cut-out : Ø85mm  
 Current : 700mA

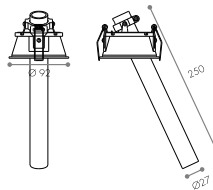

**Model No.: PRO-198**

Housing Material : Aluminium Die-Cast  
 Body Colour : White / Black  
 Power : 9W  
 Light Source : CREE LED  
 Col. Temp : 3000K / 4000K  
 Beam Angle : 15°  
 CRI : 80  
 Rotates : 355°  
 Size : Ø60mm x H195mm  
 Cut-out : Ø50mm  
 Current : 700mA

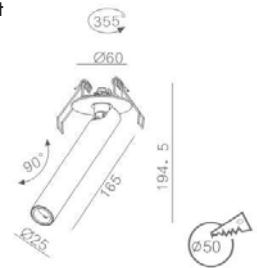

## MAGNETIC TRIMLESS - DIRECTIONAL SPOT LIGHT

### Model No.: PRO-205

Housing Material : Aluminium Die-Cast  
 Body Colour : Black  
 Power : 2x5W  
 Light Source : CREE LED  
 Col. Temp : 3000K / 4000K  
 Beam Angle : 24°  
 CRI : 80  
 Current : 600mA/9V  
 OD : 70x70x56mm  
 CD : 100x100mm  
 Luminous Flux : 100Lm/W

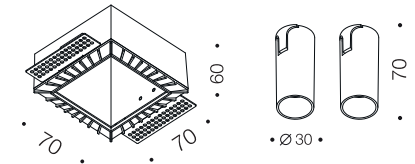

### Installation Step by Step

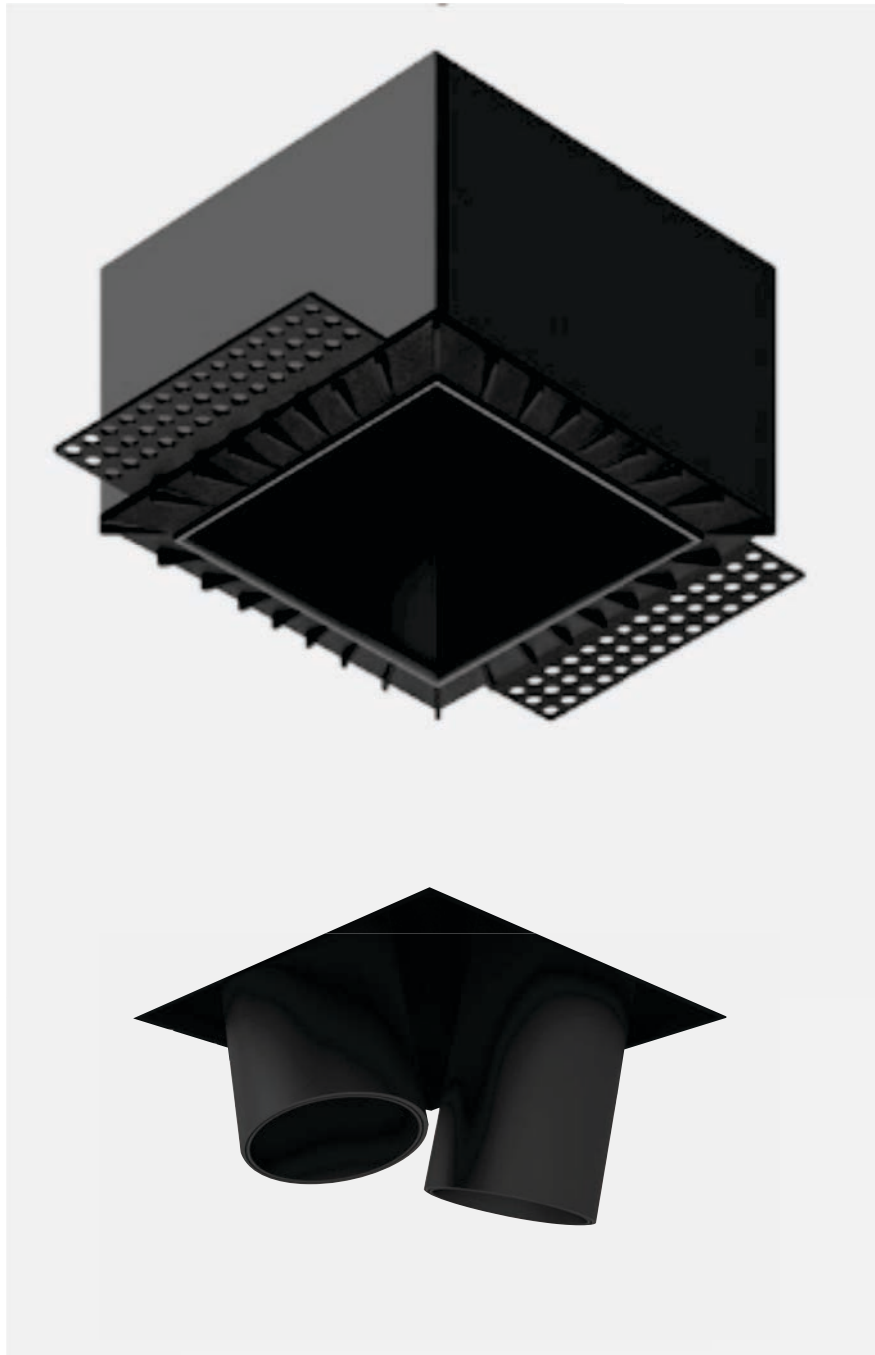
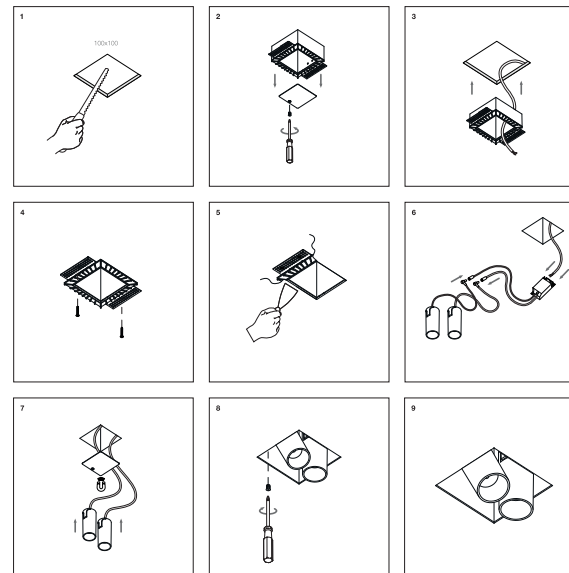

# MAGNETIC TRIMLESS - 3 WAY DIRECTIONAL SPOT LIGHT



**Model No.: PRO-206**

Housing Material : Aluminium Die-Cast  
 Body Colour : Black  
 Power : 40W  
 Light Source : CREE LED  
 Col. Temp : 3000K / 4000K  
 Beam Angle : 30°  
 CRI : 80  
 Current : 700mA/18V  
 OD : 322x322x122mm  
 CD : 267x267mm  
 Luminous Flux : 85Lm/W

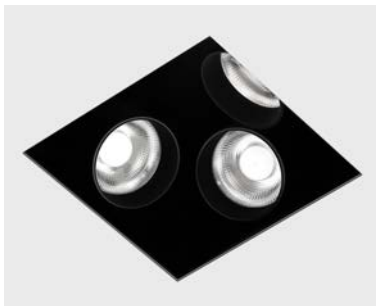
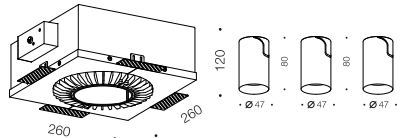

**Model No.: PRO-207**

Housing Material : Aluminium Die-Cast  
 Body Colour : Black  
 Power : 40W  
 Light Source : CREE LED  
 Col. Temp : 3000K / 4000K  
 Beam Angle : 30°  
 CRI : 80  
 Current : 700mA/18V  
 OD : 322x322x122mm  
 CD : 267x267mm  
 Luminous Flux : 85Lm/W

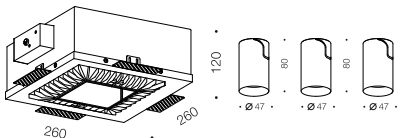

**Installation Step by Step**

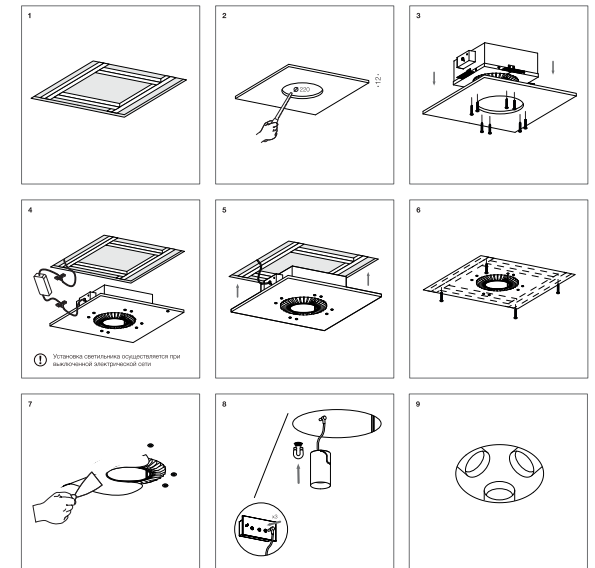

## TRIMLESS CIRCLE OF LIGHT

---

Super unique collection, slim black rings, floating through the space, providing star sky effect on the ceiling. The circle of LEDs specially designed to guarantee a uniform and balanced areole form light effect. Recessed version is equipped with magnet mechanism for LED source special fixation.

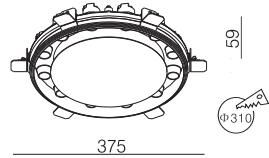

**Model No.: PRO-213**

Housing Material : Aluminium Die-Cast  
Body Colour : Black  
Power : 12x2.2W  
Light Source : OSRAM LED  
Col. Temp : 3000K / 4000K  
Beam Angle : 14°  
CRI : 80  
Current : 700mA/20.75V DC

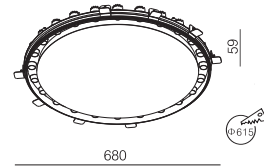

**Model No.: PRO-214**

Housing Material : Aluminium Die-Cast  
Body Colour : Black  
Power : 24x2.2W  
Light Source : OSRAM LED  
Col. Temp : 3000K / 4000K  
Beam Angle : 14°  
CRI : 80  
Current : 700mA/20.75V DC (2 drivers)





## TRIMLESS LINEAR SPOT LIGHT SERIES

---

The power of Linear spot light is 6.2W for each lamp. Available n 3 lamps and 7 lamps. During actual us, if necessary one can remove any of the lamp to achieve the purpose of reducing the lumen.

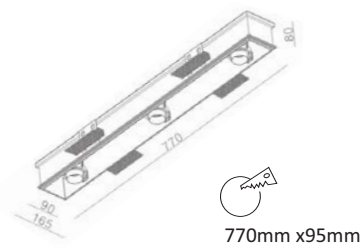

770mm x95mm

**Model No.: PRO-217**

Housing Material : Aluminium Die-Cast  
 Body Colour : Black  
 Power : 3x6.2W  
 Light Source : BRIDGELUX LED  
 Col. Temp : 3000K / 4000K  
 Beam Angle : 15°  
 CRI : 80  
 Current : 350mA (3 drivers)

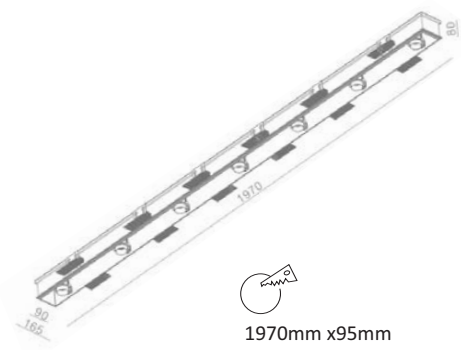

1970mm x95mm

**Model No.: PRO-219**

Housing Material : Aluminium Die-Cast  
 Body Colour : Black  
 Power : 7x6.2W  
 Light Source : BRIDGELUX LED  
 Col. Temp : 3000K / 4000K  
 Beam Angle : 15°  
 CRI : 80  
 Current : 350mA (7 drivers)







# FIND ME SPOT LIGHT SERIES

## FIND ME SPOT LIGHT SERIES



**Model No.: PRO-231 (TRIMLESS)**

Housing Material : Aluminium Die-Cast  
 Body Colour : White / Black  
 Power : 3W  
 Light Source : CREE LED  
 Col. Temp : 3000K / 4000K  
 Beam Angle : 36°  
 CRI : 80  
 Current : 350mA/9V  
 OD : Ø65x84mm  
 CD : Ø47mm  
 Luminous Flux : 110Lm/W



ø 47 (Cut out)



**Model No.: PRO-232 (WITH RIM)**

Housing Material : Aluminium Die-Cast  
 Body Colour : White / Black  
 Power : 3W  
 Light Source : CREE LED  
 Col. Temp : 3000K / 4000K  
 Beam Angle : 36°  
 CRI : 80  
 Current : 350mA/9V  
 OD : Ø54x84mm  
 CD : Ø49mm  
 Luminous Flux : 110Lm/W



ø 49 (Cut out)





**Model No.: PRO-234 (TRIMLESS)**

Housing Material : Aluminium Die-Cast  
Body Colour : White / Black  
Power : 10W  
Light Source : CREE LED  
Col. Temp : 3000K / 4000K  
Beam Angle : 30°  
CRI : 80  
Current : 350mA/9V  
OD : Ø90x126mm  
CD : Ø82mm  
Luminous Flux : 110Lm/W

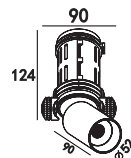

65 (Cut out)



**Model No.: PRO-235 (WITH RIM)**

Housing Material : Aluminium Die-Cast  
Body Colour : White / Black  
Power : 10W  
Light Source : CREE LED  
Col. Temp : 3000K / 4000K  
Beam Angle : 30°  
CRI : 80  
Current : 300mA/9V  
OD : Ø90x126mm  
CD : Ø82mm  
Luminous Flux : 110Lm/W

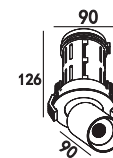

82 (Cut out)





# TRIMLESS DEEP ANTI-GLARE ADJUSTABLE LIGHT



**Model No.: PRO-237**

Housing Material : Aluminium Die-Cast  
 Body Colour : Black  
 Power : 5W  
 Light Source : CREE LED  
 Col. Temp : 3000K / 4000K  
 Beam Angle : 24°  
 CRI : 80  
 Current : 500mA/18V  
 OD : 117x30x45mm  
 CD : 83x32mm  
 Luminous Flux : 90Lm/W

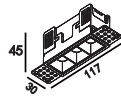

83x32(Cut out)



**Model No.: PRO-238**

Housing Material : Aluminium Die-Cast  
 Body Colour : Black  
 Power : 9W  
 Light Source : CREE LED  
 Col. Temp : 3000K / 4000K  
 Beam Angle : 24°  
 CRI : 80  
 Current : 500mA/18V  
 OD : 185x30x45mm  
 CD : 151x32mm  
 Luminous Flux : 90Lm/W

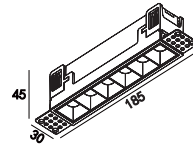

151x32(Cut out)



**Model No.: PRO-239**

Housing Material : Aluminium Die-Cast  
 Body Colour : Black  
 Power : 14W  
 Light Source : CREE LED  
 Col. Temp : 3000K / 4000K  
 Beam Angle : 24°  
 CRI : 80  
 Current : 500mA/18V  
 OD : 252x30x45mm  
 CD : 218x32mm  
 Luminous Flux : 90Lm/W

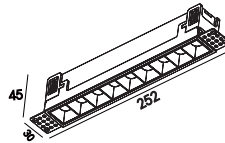

218x32(Cut out)



Push #1  
Click & Fixed



Push #2  
Click & Fixed



Push #3  
Click & Fixed



Push #4  
Click & Fixed





## IP54 - SURFACE SPOT LIGHT SERIES

### Dimming Mode : Triac Dimming

Square and Rectangle Shape Surface Spot Lights, Available in 15W and 2x15W

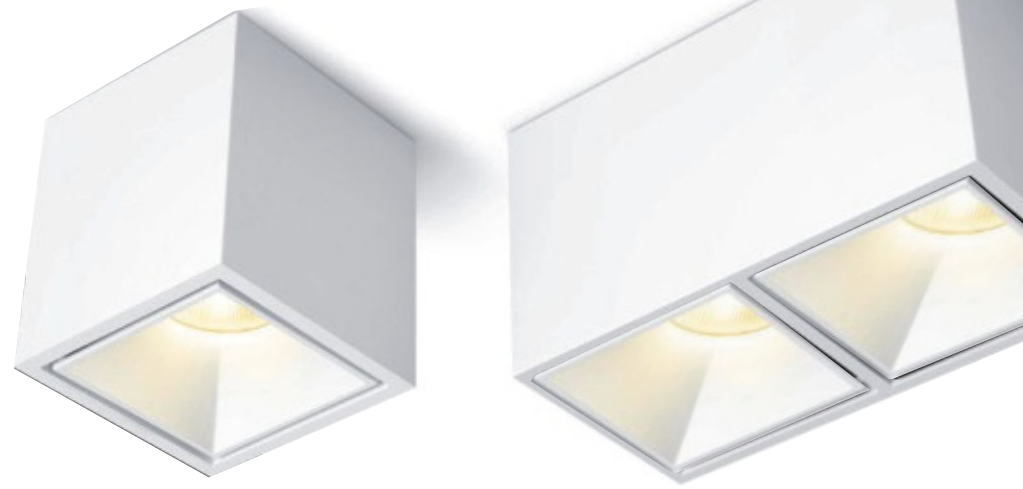

#### Model No.: PRO-301

Housing Material : Aluminium Die-Cast  
 Body Colour : White / Black  
 Power : 15W  
 Light Source : BRIDGELUX LED  
 Col. Temp : 3000K / 4000K  
 Beam Angle : 28°  
 CRI : 90

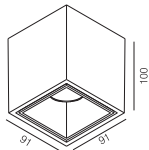

#### Model No.: PRO-302

Housing Material : Aluminium Die-Cast  
 Body Colour : White / Black  
 Power : 38W  
 Light Source : BRIDGELUX LED  
 Col. Temp : 3000K / 4000K  
 Beam Angle : 28°  
 CRI : 90

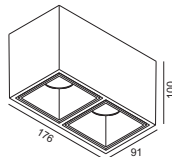

#### NEW Model No.: PRO-307

Housing Material : Aluminium Die-Cast  
 Body Colour : White / Black  
 Power : 8W  
 Light Source : BRIDGELUX LED  
 Col. Temp : 3000K / 4000K  
 Beam Angle : 32°  
 CRI : 90

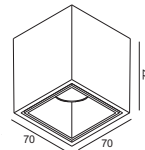

#### NEW Model No.: PRO-308

Housing Material : Aluminium Die-Cast  
 Body Colour : White / Black  
 Power : 16W  
 Light Source : BRIDGELUX LED  
 Col. Temp : 3000K / 4000K  
 Beam Angle : 30°  
 CRI : 90

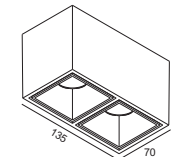



## SURFACE SPOT LIGHT SERIES

Simple design and compact size makes the surfaced mounted fixture more and more popular. Deeply installed light source gives soft and harmonious light with best anti-glare effect.

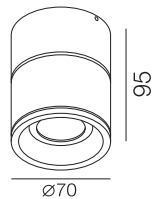

**Model No.: PRO-304**

Housing Material : Aluminium Die-Cast  
Body Colour : White  
Power : 7W  
Light Source : BRIDGELUX LED  
Col. Temp : 3000K / 4000K  
Beam Angle : 28°  
CRI : 80

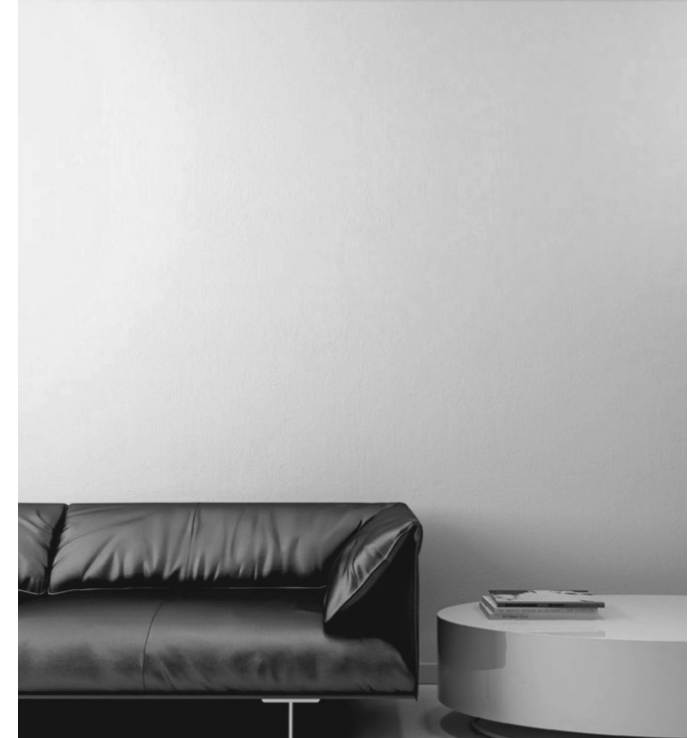



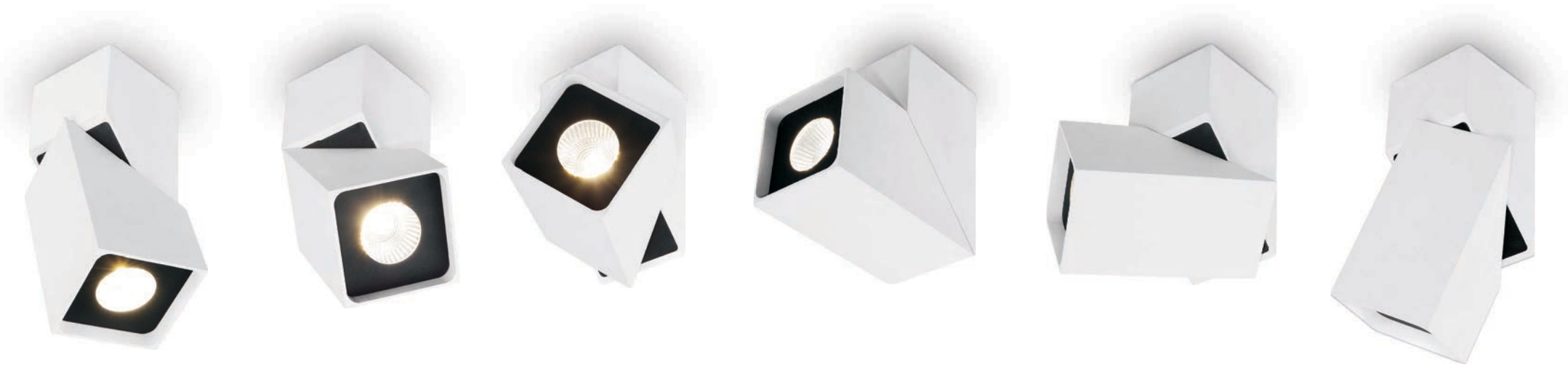

## TURN SURFACE SPOT LIGHT SERIES

Turn, as the name of the fixture indicates, can be rotated in different directions however needed. The body of TURN can be tilted to 90 degree angle, and rotated no less than 350 degrees.

Special structure provides maximum flexibility to the fitting giving best lighting performance to the room.



### Model No.: PRO-305

Housing Material : Aluminium Die-Cast  
 Body Colour : White  
 Power : 10W  
 Light Source : BRIDGELUX LED  
 Col. Temp : 3000K / 4000K  
 Beam Angle : 28°  
 CRI : 90

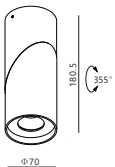

### Model No.: PRO-306

Housing Material : Aluminium Die-Cast  
 Body Colour : White  
 Power : 10W  
 Light Source : BRIDGELUX LED  
 Col. Temp : 3000K / 4000K  
 Beam Angle : 28°  
 CRI : 90

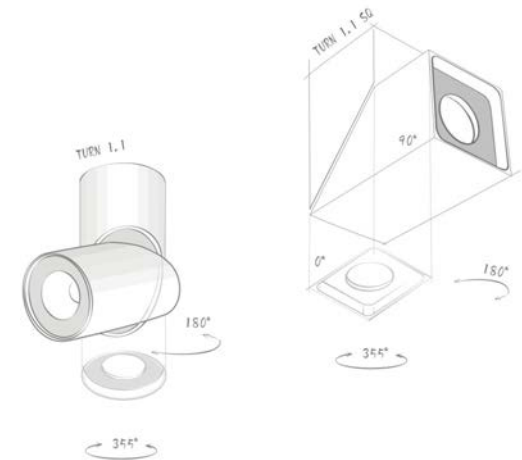
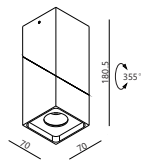





## SURFACE SPOT LIGHT SERIES

Different Shapes and Sizes Architectural Surface Light.



### Model No.: PRO-310

Housing Material : Aluminium Die-Cast  
Body Colour : White / Black  
Power : 15W  
Light Source : BRIDGELUX LED  
Col. Temp : 3000K / 4000K  
Beam Angle : 40°  
CRI : 90

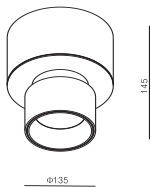

### Model No.: PRO-312

Housing Material : Aluminium Die-Cast  
Body Colour : White  
Power : 15W  
Light Source : BRIDGELUX LED  
Col. Temp : 3000K / 4000K  
Beam Angle : 32°  
CRI : 90

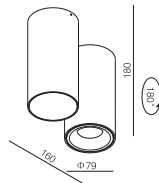

### Model No.: PRO-314

Housing Material : Aluminium Die-Cast  
Body Colour : White  
Power : 11W  
Light Source : BRIDGELUX LED  
Col. Temp : 3000K / 4000K  
Beam Angle : 32°  
CRI : 90

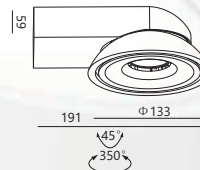

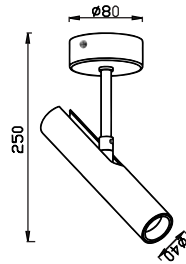

**Model No.: PRO-315**

Housing Material : Aluminium Die-Cast  
Body Colour : Black  
Power : 4W  
Light Source : CREE LED  
Col. Temp : 3000K / 4000K  
Beam Angle : 24°  
CRI : 90

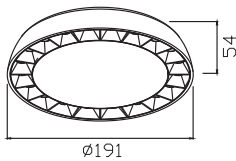

**Model No.: PRO-317**

Housing Material : Aluminium Die-Cast  
Body Colour : White  
Power : 15W  
Light Source : BRIDGELUX LED  
Col. Temp : 3000K  
Beam Angle : 24°  
CRI : 90



## IP54 - CONCEALED FOOT/STEP LIGHT

The light comes out from a deep shelter of the light. The concealed foot light with IP54 grade give the path a different look.

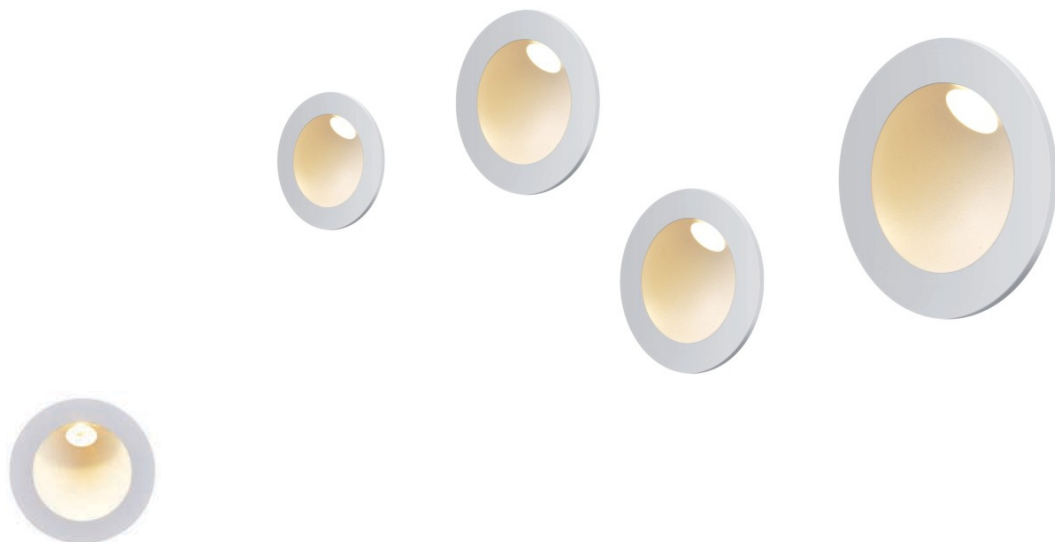

**Model No.: PRO-341**

Housing Material : Aluminium Die-Cast  
Body Colour : White  
Power : 2.2W  
Light Source : OSRAM LED  
Col. Temp : 3000K / 4000K  
CRI : 80  
Current : 700mA

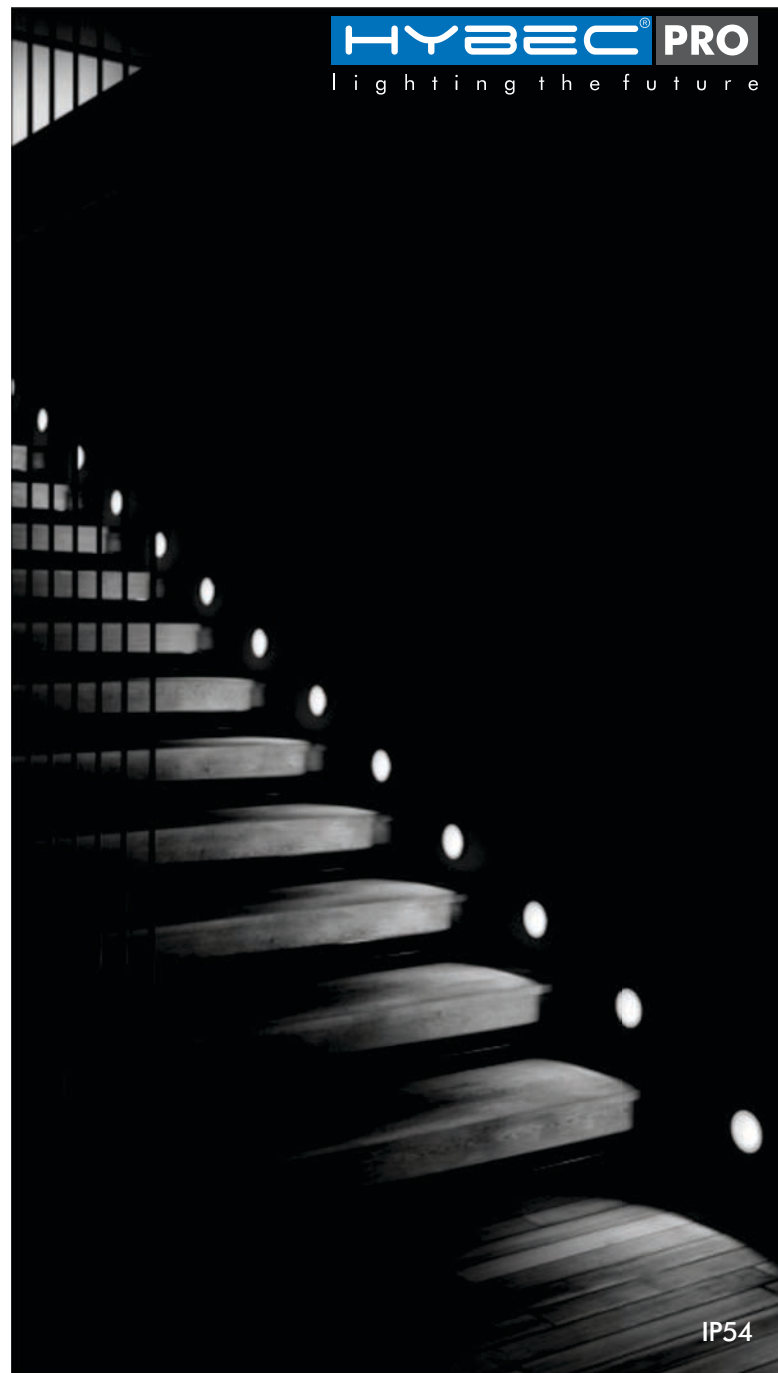
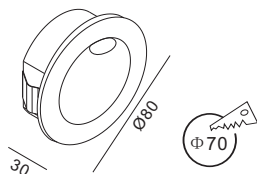

**HYBEC<sup>®</sup> PRO**  
lighting the future

IP54

IP65

## IP65 - CONCEALED FOOT/STEP LIGHT

The unique design of the inner ring makes the IP65 concealed foot/step light soft and delicate. It can be used as stair lamp also night lamp.



### Model No.: PRO-351

Housing Material : Aluminium Die-Cast  
Body Colour : White / Black  
Power : 1W  
Light Source : CREE LED  
Col. Temp : 3000K / 4000K  
Beam Angle : 32°  
CRI : 90  
Current : 350mA

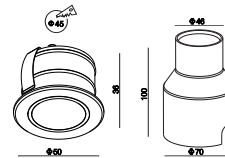

**HYBEC<sup>®</sup> PRO**  
lighting the future



## IP65-IP67 GRADE LED OUTDOOR LIGHT SERIES

---

HYBECPRO outdoor fittings are all IP GRADE fittings, ranging from surface wall lights, wall washer surface lights, pathway lights, step lights and spike lights.





## IP65 - SURFACE CEILING LIGHT



**Model No.: PRO-645**

Housing Material : Aluminium Die-Cast  
Body Colour : Grey  
Power : 13W  
Light Source : CREE LED  
Col. Temp : 3000K  
Beam Angle : 30°  
CRI : 80

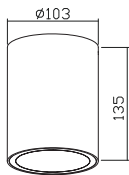

**Model No.: PRO-646**

Housing Material : Aluminium Die-Cast  
Body Colour : Grey  
Power : 26W  
Light Source : CREE LED  
Col. Temp : 3000K  
Beam Angle : 30°  
CRI : 80

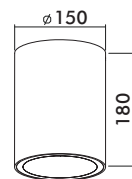

**HYBEC<sup>®</sup> PRO**  
lighting the future

## IP65 - ASYMMETRIC SURFACE CEILING WALL WASHER



### Model No.: PRO-647

Housing Material : Aluminium Die-Cast  
Body Colour : Grey  
Power : 8W  
Light Source : CREE LED  
Col. Temp : 3000K  
Beam Angle : 30°  
CRI : 80

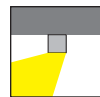
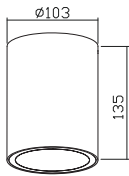

### Model No.: PRO-648

Housing Material : Aluminium Die-Cast  
Body Colour : Grey  
Power : 18W  
Light Source : CREE LED  
Col. Temp : 3000K  
Beam Angle : 30°  
CRI : 80

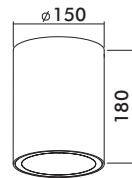



# IP67 GRADE LED OUTDOOR IN-GROUND LIGHT



**Model No.: PRO-664**

Housing Material : Aluminium Die-Cast  
Body Colour : SS  
Power : 10W  
Light Source : CREE LED  
Col. Temp : 3000K  
Beam Angle : 30°  
CRI : 80

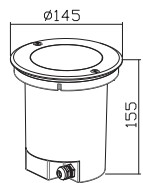

**Model No.: PRO-665**

Housing Material : Aluminium Die-Cast  
Body Colour : SS  
Power : 10W  
Light Source : CREE LED  
Col. Temp : 3000K  
Beam Angle : 30°  
CRI : 80

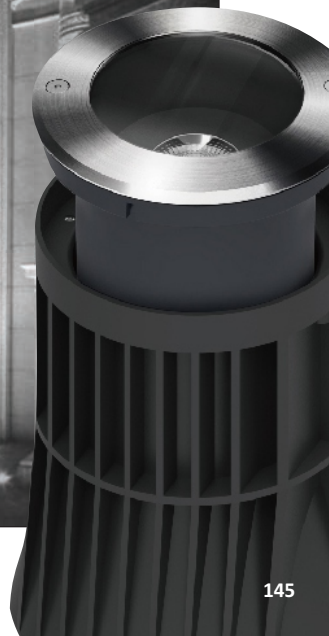
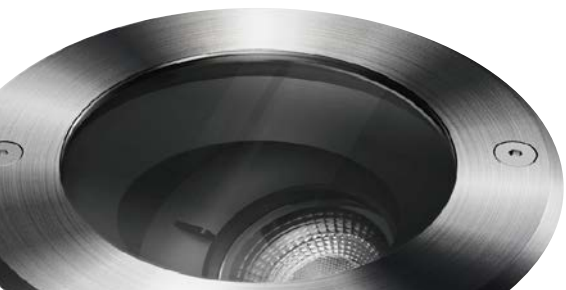
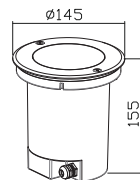



## IP67 GRADE LED FLOOD LIGHT - 1 DEGREE



**Model No.: PRO-670**

Housing Material : Aluminium Die-Cast  
Body Colour : Graphite Grey  
Power : 10W  
Light Source : CREE LED  
Col. Temp : 3000K  
Beam Angle : 1°  
CRI : 80

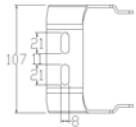
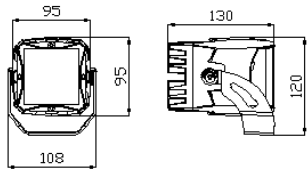

## IP65 - CONCEALED DIFFUSED STEP LIGHT



### Model No.: PRO-672

Housing Material : Aluminium Die-Cast  
 Body Colour : Grey  
 Power : 3W  
 Light Source : CREE LED  
 Col. Temp : 3000K  
 Beam Angle : 30°  
 CRI : 80

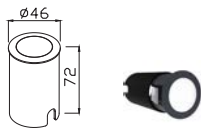

φ44mm(Cut out)



### Model No.: PRO-673

Housing Material : Aluminium Die-Cast  
 Body Colour : Grey  
 Power : 3W  
 Light Source : CREE LED  
 Col. Temp : 3000K  
 Beam Angle : 30°  
 CRI : 80

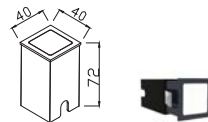

φ39x39mm(Cut out)



## IP66 - SURFACE SPOT PROJECTION LIGHT



**Model No.: PRO-677**

Housing Material : Aluminium Die-Cast  
 Body Colour : Grey  
 Power : 10W  
 Light Source : CREE LED  
 Col. Temp : 3000K  
 Beam Angle : 30°  
 CRI : 80

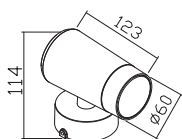

**Model No.: PRO-678**

Housing Material : Aluminium Die-Cast  
 Body Colour : Grey  
 Power : 18W  
 Light Source : CREE LED  
 Col. Temp : 3000K  
 Beam Angle : 30°  
 CRI : 80

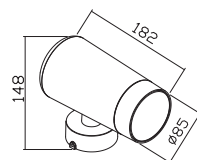

**SPIKE**

**TREE BELT 2MTR**



**Model No.: 51**

**Model No.: 52**





## IP67 - DOT FREE FLEXI STRIP

Slimmest 5MM flexi strip has a seamless and uniform light output, totally DOT free.  
Robust housing with high quality silicone can be used for outdoor facade illumination.  
It can be bended at horizontal direction. Comes in Dome and Flat surface.



- Silicone extruded process, IP67
- High color consistency, soft and uniform light
- Eco-friendly silicone material, long lifespan
- Easy installation

## 5MM / 8MM - FLAT TYPE - 24V



### Model No.: PRO-251

Housing Material : PVC Body  
 Body Colour : White  
 Power : 10W / MTR.  
 Light Source : 2835 - 120LED  
 Col. Temp : 3000K / 4000K / BLUE  
 Protection : IP67  
 Input Voltage : 24VDC  
 Dimension : 5x12mm  
 Packing : 5MTR/ROLL

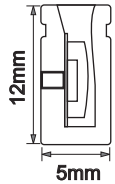

## 8MM - DOME TYPE - 24V



### Model No.: PRO-252

Housing Material : PVC Body  
 Body Colour : White  
 Power : 12W / MTR.  
 Light Source : 2835 - 120LED  
 Col. Temp : 3000K / 4000K / BLUE  
 Protection : IP67  
 Input Voltage : 24VDC  
 Dimension : 8x16x10mm  
 Packing : 5MTR/ROLL

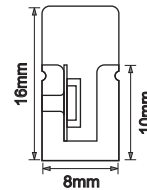

### ACCESSORIES KIT



End cap with hole    End cap without hole    Bracket    End cap glue    Glue ip mouth    Screw

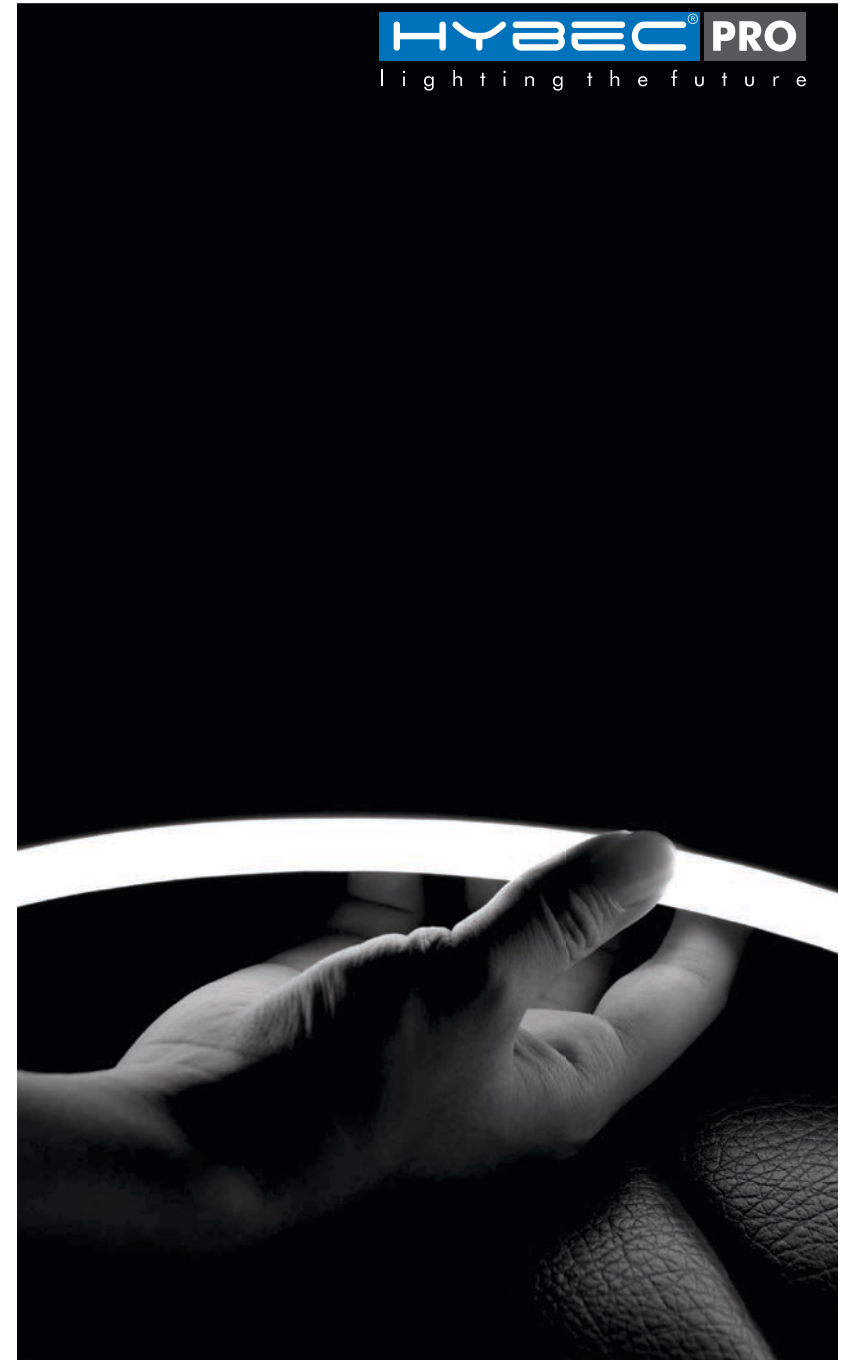





NEW

## IP67 - DOT FREE RIGID LINES

Assortment of rigid IP67 luminaires complementing the flexible line-up for straight lines application on facade, landscapes as well as ambient lighting. Each luminaire consists an extruded aluminum housing in combination with polyurethane encapsulation material offering an optimal waterproof sealing, UV resistance chemical stability against urban and protection against abrasion damages.



BOSTON PRIVATE BANK  
& TRUST COMPANY



## IP67 - DOT FREE RIGID LINES

Compact and robust dot free luminaire that is a rigid with cable groove on its backside. It fascinates with a simple installation with separate aluminum profile without visible light joints and connections.

High protection against vandalism thanks to a robust, powder-coated aluminum profile with an IK10 rating.

Polyurethane is utilized to make it more resistant to impact from salt water UV light and solvents.

The end caps combined with smart cabling and mounting management operated on the back grove the profile enables infinite light lines without dark or hot spots.

### Model No.: PRO-257



Material : Polyurethane  
Body Colour : White  
Power : 10W / MTR.  
Light Strip In-Built : 2835 - 120LED/mtr.  
Col. Temp : 3000K  
Protection : IP67  
Input Voltage : 24VDC  
Dimension : W18mm x H14mm  
Length : 1 MTR.

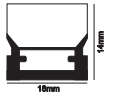

**Wiring : 200mm Cable at the Bottom, with IP67 Connector.**

### Aluminium Base :

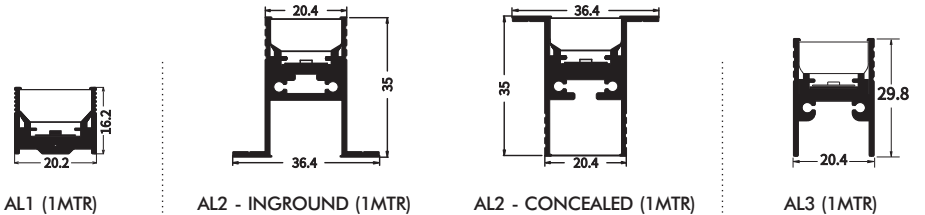

-  Temporary Immersion Protection
-  Impact Resistant
-  UV Protected
-  Saltwater Resistant
-  Resistant To Solvents
-  LM79 Compliant
-  Lifetime 50000 Hrs. at 25° C

# IP67 - DOT FREE RIGID LINES



**Model No.: PRO-258**

Material : Polyurethane  
 Body Colour : White  
 Power : 15W / MTR.  
 Light Strip In-Built : 2835 - 120LED/mtr.  
 Col. Temp : 3000K  
 Protection : IP67  
 Input Voltage : 24VDC  
 Dimension : W22mm x H18mm  
 Length : 1 MTR.

**Wiring : 200mm Cable at the Bottom, with IP67 Connector.**



## Aluminium Base :

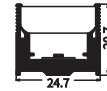

AL4 (1MTR)



AL9  
(MALE/FEMALE CONNECTOR)

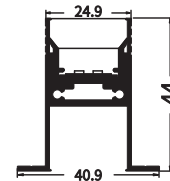

AL5 - INGROUND (1MTR)



AL5 (END CAP)

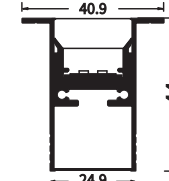

AL5 - CONCEALED (1MTR)



AL5 (END CAP)

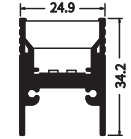

AL6 (1MTR)



AL6 (END CAP)

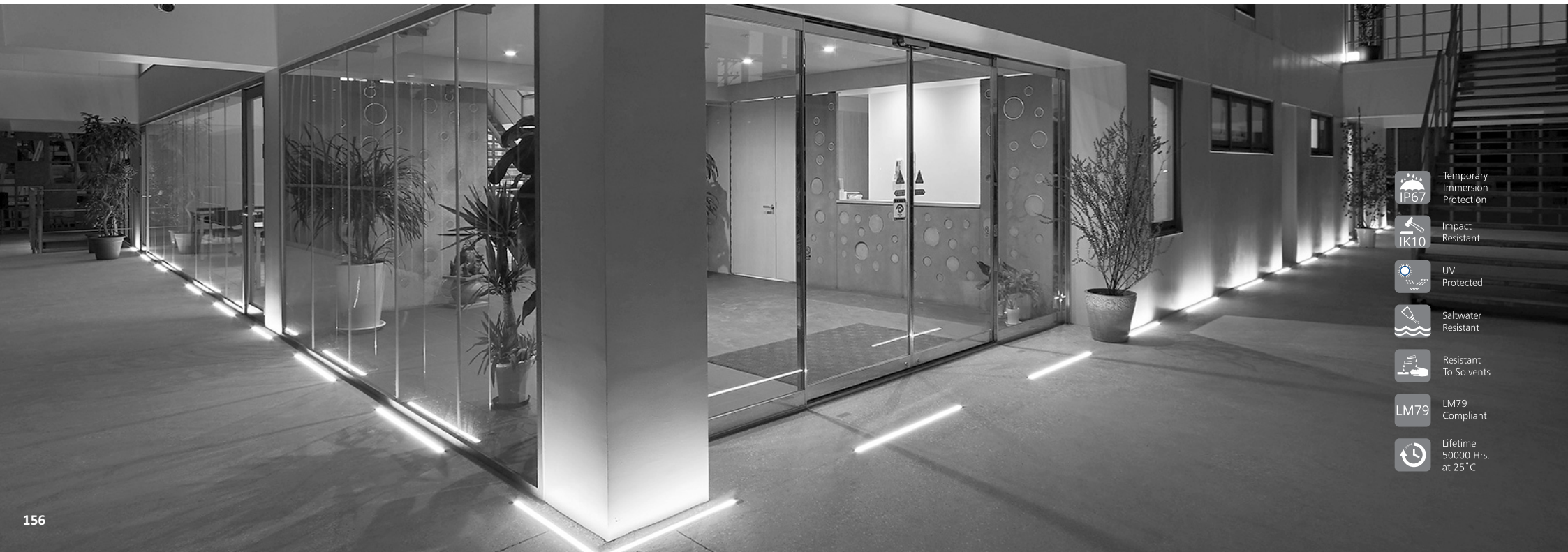

- Temporary Immersion Protection
- Impact Resistant
- UV Protected
- Saltwater Resistant
- Resistant To Solvents
- LM79 Compliant
- Lifetime 50000 Hrs. at 25°C

# IP67 - DOT FREE RIGID LINES



## Model No.: PRO-259

Material : Polyurethane  
 Body Colour : White  
 Power : 30W / MTR.  
 Light Strip In-Built : 2835 - 240LED/mtr.  
 Col. Temp : 3000K  
 Protection : IP67  
 Input Voltage : 24VDC  
 Dimension : W36mm x H36mm  
 Length : 1 MTR.  
**Wiring : 200mm Cable at the Bottom,  
 with IP67 Connector.**



### Aluminium Base :

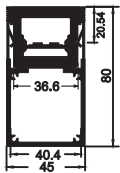

AL7 (1MTR)

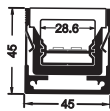

AL8 (1MTR)



AL10  
(MALE/FEMALE  
CONNECTOR)



AL7 (END CAP)



AL8 (END CAP)



Temporary Immersion Protection



Impact Resistant



UV Protected



Saltwater Resistant



Resistant To Solvents



LM79 Compliant



Lifetime 50000 Hrs. at 25°C





[www.hybec.net](http://www.hybec.net)

**HYBEC<sup>®</sup> PRO**  
lighting the future